

Examination room furniture



Merivaara has been a specialist manufacturer of high-quality medical equipment for more than 100 years, turning out its first operating table in 1910. The company manufactures all core equipment for today's modern hospitals. It covers a wide spectrum of hospital furniture, including operating tables, operating and examination lights, beds and bed stands, delivery beds, trolleys and examination tables. Products developed and manufactured by Merivaara are distributed worldwide to more than 100 countries.

All products are CE labelled and Merivaara's quality system complies with the ISO 9001:2000 and ISO 13485:2003 standards. The company's environmental management system is ISO 14001:2004 certified.



A well-functioning examination room contains a wide range of multifunctional treatment furniture and equipment to facilitate examination and treatment.

Merivaara examination room furniture is practical and easy to use. Our comprehensive range is designed to meet and exceed the requirements of modern health centres and hospitals as well as private clinics. With Merivaara examination room furniture and various table colour options an entire room can easily be furnished according to a visual concept or add the required equipment. Our selection includes examination tables, trolleys, working chairs, curtains, steps and examination lamps. Merivaara products offer an exceptional quality for the value that combines practicality with working ergonomics. The examination room furniture is robust and durable, with a functional design enabling easy cleaning and maintenance. The accessories have been specially designed with practicality and efficiency for treatment process in mind.



409 examination table is an economical solution for general medical examinations and minor operations. Thanks to its clear structure 409 is easy and ergonomic to use and quick to clean. Wide range of accessories guarantees comfort and efficiency for medical professionals.

- electric and hydraulic models available
- optional Trendelenburg
- upholstery easy-to-clean artificial leather, several colour options available (see colours on page 5)
- push bars at both ends

Technical specifications

Mattress base	2-sectional, epoxy powder coated steel frame
Weight	ca. 80 kg
SWL	180 kg
Length	2030 mm
Width	705 mm
Height	590 - 960 mm
Castors	125 mm, individual braking system 125 mm and 150 mm, central braking system

Adjustments

Backsection	-20 ... +54°, electric or gas spring assisted
Height	590 - 960 mm electric or hydraulic adjustment
Trendelenburg	0 ... 14°, anti-Trendelenburg 0 ... 7°

Accessories and Options

100000732	paper roll holder 732
100000734	paper cutter 734
100000583	wire basket 583, lower frame (hydraulic model only)
100005841	ABS utility basket 5841, head end of the lower frame (hydraulic model only)
100005851	ABS utility basket 5851, leg end of the lower frame (hydraulic model only)
100005861	ABS utility basket 5861 to lower frame for el. models
100000700	accessory rail 700, pair
100000977	Trendelenburg and anti-Trendelenburg adjustment

Warranty 3 years



Provided with specified accessories conforms to the European Council Directive 93/42/EEC, Medical Device Directive Annex VII and the corresponding Finnish National Law No. 1505 (1994) and regulation no. 1506 (1994). The products is controlled in accordance with ISO 9001 and ISO 13485 Quality Management Systems and ISO 14001 Environmental Management System.



Merivaara's examination table 408 is an economical, basic model for general examination and small procedures with stepless head section adjustment.

- practical and easy to use
- for general examinations and small operations
- upholstery easy-to-clean artificial leather, several colour options available
- stepless adjustment of the head section angle included
- equipped with a paper roll holder (paper roll max width 525 mm)

Technical specifications

Mattress base	2-sectional, epoxy coated steel frame
Weight	ca 30 kg
SWL	135 kg
Length	1900 mm
Width	655 mm
Height	745 mm





Adjustments

Head section - 20° ... + 74°

100000408	408 examination table, 2-sectional, including paper roll holder+head section adjustment
100000446	mounting step

Warranty 3 years

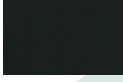
Examination table colour options:

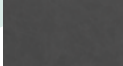
	Beige 0222
	Green 8549
	Black 0000
	Blue 2819
	Bluish Grey 0887
	Grey 0705



Provided with specified accessories conforms to the European Council Directive 93/42/EEC, Medical Device Directive, Annex VII and the corresponding Finnish National Law and regulation.

The product is controlled in accordance with ISO 9001 and ISO 13485 Quality Management Systems and ISO 14001 Environmental Management System.



Model 4242 can be used both in gynaecological and general medical examinations as well as in minor operations. The examination table combines ease of use with a practical design and ergonomic functions. A wide range of accessories and practical adjustment possibilities guarantee the comfort and efficiency of the medical professionals.

- both electric and hydraulic models available
- for general or gynaecological examinations
- functional design
- two-sectional soft and shaped mattress base
- upholstery easy-to-clean artificial leather, several colour options available (see colours on previous page)
- wide range of accessories

Technical specifications

Mattress base	2-sectional (+ extension accessory)
	epoxy powder coated steel frame
Weight	75 kg - 80 kg
SWL	180 kg
Length	1550 mm, 1910 mm with extension
Width	Hydr. 735 mm, mattress base width 630 mm Elect. 670 mm, mattress base width 630 mm
Height	580 - 940 mm
Castors	125 mm, individual braking system 125 mm and 150 mm, central braking system

Adjustments

Back section	0° ... + 67° gas spring assisted or electric adjustment
Height	580 - 940 mm hydraulic or electric height adjustment

Accessories and Options

100034149	extension (leg section) + mattress base code 100004150 - 100004155 depending on colour
100000572	paper roll holder 572
100000597	bowl and fixing part 597
100000574	accessory rails for the back section 574, pair
100000573	accessory rails for the seat section 573, pair
100000741	side rails 741, pair
100000428	knee supports 428, pair
100000426	heel supports 426, pair
100010200	Universal clamp 10200, 2 pcs for fixing 428
100000118	Knee supports 118
100010300	Fixing clamps 10300, 2 pcs for 118
100000583	wire basket 583, lower frame (hydraulic model only)
100005851	utility basket 5851, lower frame (hydraulic model only)

Warranty 3 years

Provided with specified accessories conforms to the European Council Directive 93/42/EEC, Medical Device Directive Annex VII and the corresponding Finnish National Law No. 1505 (1994) and regulation no. 1506 (1994).

The products is controlled in accordance with ISO 9001 and ISO 13485 Quality Management Systems and ISO 14001 Environmental Management System.





Examination table 417 and step 446

Examination table 417 is a basic model for general and gynaecological examinations and minor procedures. Table includes stepless adjustments for head- and back section. Adjustable heel supports, paper roll holder and a stainless steel bowl are also included in the price.

- economical model, easy to use
- table includes stepless adjustments for head- and back section
- upholstery easy-to-clean artificial leather, several colour options available (see colour options on page 5)
- includes adjustable heel supports, stainless steel bowl and paper roll holder (paper roll max width 525 mm)

Technical Specifications

Mattress base	3-sectional, epoxy coated steel frame
Length	1895 mm
Width	645 mm
Height	850 mm
Weight	44 kg
SWL	135 kg

Adjustments

Head section	- 90° ... + 48°
Back section	0° ... + 62°

100000417 examination table 417

Accessories

100000428	knee supports 428, pair
100000427	clamp 427 for fixing knee supports 428
100000418	accessory rails 418, pair
100000446	mounting step

Warranty 3 years



Gynaecological position



The knee supports with fixing attachments



Provided with specified accessories conforms to the European Council Directive 93/42/EEC, Medical Device Directive, Annex VII and the corresponding Finnish National Law and regulation.

The product is controlled in accordance with ISO 9001 and ISO 13485 Quality Management Systems and ISO 14001 Environmental Management System.

Medical lamps

- Even, effective light
- Wide turning radius, easy to focus
- Long-life bulb, easy to replace
- Stylish design, easy to clean
- Triple IR-filtering RA 94

Merilux X1 examination lamps can be used e.g. in examination rooms and day surgery departments. The lamp is available with ceiling or wall mounting and as a freely moving floor model. The lamp has a fixed focus (500 – 1500 mm), and the produced light is even and infrared filtered. Merivaara use Triple IR filtering for more (IR) natural appearance and richer colours.



The lamp has a metal facet reflector with 1968 small plane mirrors producing a wider, more effective and more even light field.

Merilux X1 FM Swing model features an articulated arm that is particularly well suited to gynaecological examinations. When folded down, the lamp requires very little space.



Merilux X1

- light intensity 35,000 lux (1 m), infrared filter
- colour temperature 4300 K
- RA 94
- voltage 22.8 V
- transformer 230 VAC/50 Hz, 24 V/75 VA
- easy-to-change halogen bulb 40 W, operating life appr. 1000 h
- unbreakable outer glass
- fixed focus 500 – 1500 mm
- light field diameter 170 mm
- power switch in the lamp part
- castors on the floor model can be locked
- height of the floor model can be adjusted 1200 – 1800 mm
- size of light head Ø 290 x 110 mm
- weight of light head 1.5 kg

Options

- battery back-up in ceiling mounted (CM) and wall mounted (WM) models (operational time 3 h)

Dimensions and weights

X1 FM Swing, movable floor model

- height 1780 mm
- width 600 mm
- total weight 16 kg

X1 CM, ceiling-mounted model

- arm 800 + 920 mm
- total weight 21 kg (incl. a 850 mm ceiling pipe)
- several ceiling pipe heights

X1 WM, wall-mounted model

- arm 800 + 920 mm
- total weight 9 kg

Merilux X3 is an ideal solution e.g. in day surgery and operation rooms. A removable sterilized handle is used to direct and focus the light. A wide turning radius enables a one-hand use. The surfaces are easy to clean. The lamp is available as ceiling- and wall-mounted as well as floor model.



Due to their innovative design, Merilux lamps have extremely good laminar characteristics.

The bulbs are easy to replace. The Merilux X3 FM floor model has castors to enable easy moving. The model is available with or without a battery with an operation time of 2.5 hours.

Merilux X3

- Ra 94
- light intensity 100,000 lux (1 m), infrared filter
- colour temperature 4300 K
- voltage 22.8 V (optimal)
- transformer 230 VAC/50 Hz, 24 V/350 VA
- 3 halogen bulbs à 40 W, operating life appr. 1000 h
- unbreakable outer glass
- work distance 0.7–1.5 m
- depth of illumination 1030 mm
- light field diameter 175 – 240 mm
- focusing handle can be detached for sterilization
- castors on the floor model can be locked
- light head Ø 530 x 140 mm
- weight of the light head 8 kg

Options

- back-up battery (operation time 2.5 h)

Dimensions and weights

X3 FM, movable floor model

- height 1800 mm
- width 600 mm
- total weight 67 kg
- floor model available with or without a battery
- battery operation time 2.5 h

X3 CM, ceiling-mounted model

- arm 800 + 800 cm
- total weight 33 kg (incl. a 850 mm ceiling tube)
- several ceiling tube heights

X3 WM, wall-mounted model

- arm 800 + 800 cm
- total weight 20 kg

Step 446



- epoxy powder coated steel frame, white, robust model
 - steps are coated with anti-slip material
 - width 400 mm
 - height 360 mm
 - depth 500 mm
 - step dimensions 400 x 250 mm
- order code 100000446

Chair 465

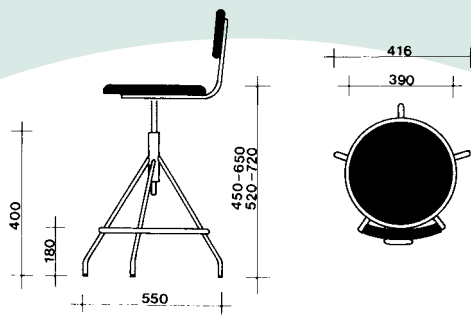

- chromed steel frame
- threaded height adjustment
- leg support
- padded seat with artificial leather, several colour options available
- 5 legs
- standard model without back rest

Accessories

- back rest in artificial leather, several colour options available
- 5 castors Ø 50 mm, 3 of which equipped with brakes





order code 100000465

Ward screen 442

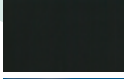

- chromed steel frame, equipped with a connection ring to enable joining multiple screens
 - curtain made of white easy-care material with a plastic coating
 - 3 castors (Ø 50 mm) enable easy moving of the screen
 - width 900 mm
 - total height 1630 mm
 - screen height 1240 mm
 - depth 460 mm
- order code 100000442

Examination table colour options:

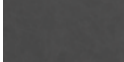
	Beige 0222
	Green 8549
	Black 0000
	Blue 2819
	Bluish Grey 0887
	Grey 0705

Instrument cabinet 510

advanced, high-quality model



- epoxy coated steel structure
- 2 aluminium profile doors, top door with a glass panel
- locking system
- removable glass shelves, adjustable height
- hooks for instruments
- pull-out auxiliary surface
- leg height can be adjusted separately
- available with right or left hand door

Dimensions

- width 600 mm
- depth 350 mm
- height 2000 mm

order code 10000510

Instrument cabinet 1510

basic model



- epoxy coated steel structure
- 2 doors, top door with a glass panel
- locking system
- removable glass shelves, adjustable height
- hooks for instruments
- pull-out auxiliary surface
- leg height can be adjusted separately
- available with right or left hand door

Dimensions

- width 600 mm
- depth 350 mm
- height 2000 mm

order code 100001510

Medicine cabinet 515

advanced, high-quality model



- epoxy coated steel structure
- 2 aluminium profile doors with locking system
- plastic shelves on top door
- removable glass shelves, adjustable height
- locker for narcotics
- pull-out auxiliary surface
- leg height can be adjusted separately
- available with right or left hand door

Dimensions

- width 600 mm
- depth 350 mm
- height 2000 mm

order code 10000510

Medicine cabinet 1515

basic model



- epoxy coated steel structure
- 2 doors with locking system
- plastic shelves on top door
- removable glass shelves, adjustable height
- locker for narcotics
- pull-out auxiliary surface
- leg height can be adjusted separately
- available with right or left hand door

Dimensions

- width 600 mm
- depth 350 mm
- height 2000 mm

order code 100001515

Merivaara trolleys

Merivaara offers wide range of trolleys for various needs and numerous use. Merivaara trolleys are strong and durable, tubular structure chromed steel, in maintenance trolley stainless steel.

- Light and durable
- Easy to move
- Wide range of models for various use

Instrument trolley 611 and 609



- chromed steel frame
- 2 removable stainless steel trays
- castors Ø 75 mm for easy moving
- model 611 features an easy-to-clean plastic utility drawer under the upper tray, opening at both sides, with pull-out restrictors
- trolleys fit under an 800 mm high working level

<i>order code</i>	<i>item</i>
100000611	instrument trolley 611
100000609	instrument trolley 609

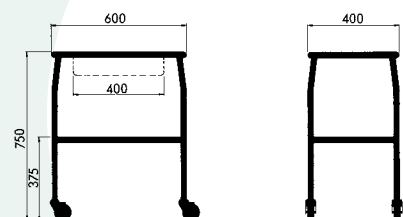

Nurse trolley 262



- chromed steel frame
- 2 fixed stainless steel trays
- push bar
- large castors (Ø 100 mm) for easy rolling
- Optional: an easy-to-clean plastic utility drawer (mounting rails below the upper tray). The drawer opens at both sides.

<i>order code</i>	<i>item</i>
100000262	nurse trolley 262

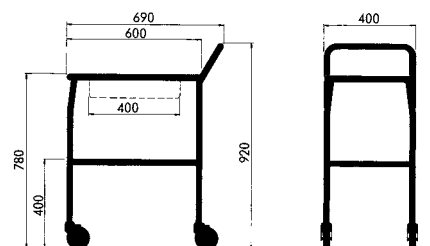

Maintenance trolley 285



- stainless steel frame
- fixed surfaces in stainless steel, raised edges prevent things from falling out
- push bar
- castors (Ø 125 mm) in corrosion resistant material, two castors with lock.

order code *item*
 100000285 maintenance trolley 285

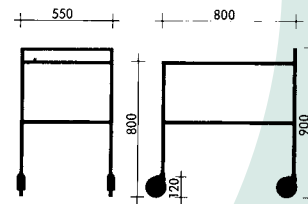

Maintenance trolley 266 • Courier trolley 265



- chromed steel frame
- baskets made of epoxy-coated steel wire
- castors Ø 100 mm
- courier trolley 265 with a 6-partition top basket

order code *item*
 100000266 maintenance trolley 266
 100000265 courier trolley 265

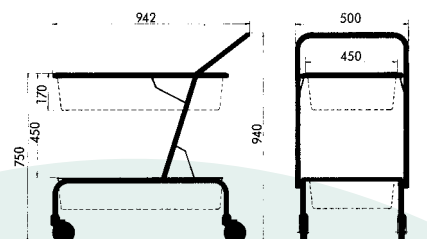

Sample trolley 255



- chromed steel frame
- removable plastic trays with side plates
- castors Ø 75 mm

order code item
100000255 sample trolley 255

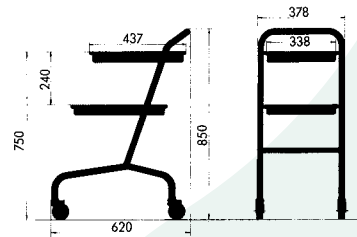

Linen trolley 270



- chromed steel frame
- 4 double baskets, epoxy-coated steel wire, designed to house both machine-folded and hand-folded linen
- castors Ø 100 mm

order code item
100000270 linen trolley 270

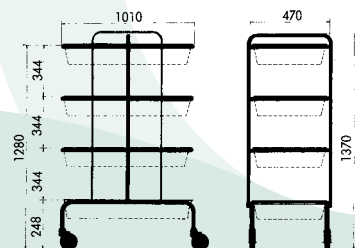

Patient chart trolley 252



- chromed steel pipe frame
- surfaces and basket made of durable epoxy-coated steel, surface edges prevent the files and X-ray pictures from falling
- wire baskets for utensils
- folding writing surface
- big directional castors, Ø 125 mm

order code item
100000252 patient chart trolley 252

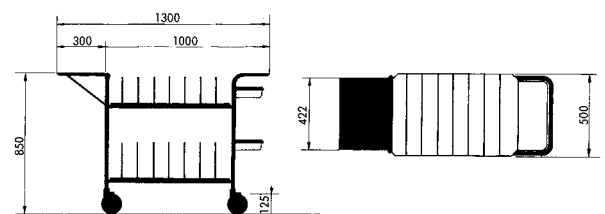

Merivaara Sack trolleys

Merivaara offers durable trolleys for laundry and garbage sacks. Tubular frame chromed steel. Push bars and big castors to facilitate the handling.

- Durable structure
- Light and easy to move and handle
- Bottom support to keep sack in place
- For laundry and garbage sacks 100 - 150 litre, cloth or plastic

Sack trolley 291



Sack trolley 292



With a foot pedal.

Sack trolley 290



<i>order code</i>	<i>item</i>
100000291	sack trolley 291
100000292	sack trolley 292 (incl. cover 410)
100000290	sack trolley 290

Accessories

<i>order code</i>	<i>item</i>
100000410	cover 410



MERIVAARA

Merivaara Corp.

Puustellintie 2, FI-15150 LAHTI, FINLAND

Tel. +358 3 3394 611, fax +358 3 3394 6144

merivaara@merivaara.fi

www.merivaara.com