

Tillbehör Operationsbord OPT serien

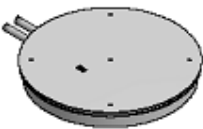

VANTO OPERATING TABLE
Column for the operating system VANTO

| | | |
|--------------------------------------|---|--|
| <p>Code: 8802000</p> |  | <p>MOBILE COLUMN VANTO WITH INTEGRATED CONTROL PANEL Mobile column of Vanto electro-mechanical operating system, with interchangeable table tops. The mobile column is mounted on a flat base of minimum thickness with chamfered edges to grant optimal stability to the entire system. It is controlled by a microprocessor with specific operating system, and is complete with a built-in keyboard included into the column.</p> |
| <p>Code: 8803000</p> |  | <p>MOBILE VANTO PLUS COLUMN WITH INTEGRATED CONTROL PANEL Mobile column of Vanto Plus electro-mechanical operating system, with interchangeable table tops. The mobile column is mounted on a flat base of minimum thickness with chamfered edges to grant optimal stability of the entire system and includes no. 2 integrated roller wheels. It is controlled by a microprocessor with specific operating system, and is complete with a built-in keyboard included into the column. It is possible to do small transfer of the entire system through a small trolley, to be ordered separately.</p> |
| <p>Code: 8849002</p> |  | <p>TROLLEY FOR MOVING VANTO PLUS AND CENTURY PLUS COLUMNS Auxiliary removable handling carriage system, particularly useful for small transfers of the entire operating system during the surgery activity in the operating theatre.</p> |
| <p>Code: 8805000</p> |  | <p>STATIONARY VANTO COLUMN WITH UNDERGROUND POWER SUPPLY AND INTEGRATED CONTROL PANEL Fixed column of VANTO fixed stationary system, with interchangeable table tops. The column is controlled by a microprocessor with specific operating system and is mounted on a support base, on machined brass, which is positioned into the floor of the operating theatre. The system comes complete with all gaskets and has a 340° rotation without obstructions, and lockable in any position through the use of an electrically operated braking system. It is complete with a built-in keyboard included into the column.</p> |
| <p>Code: 880500100500</p> | | <p>FLOOR BASE PLATE FOR STATIONARY VANTO AND CENTURY COLUMNS</p> |

| | | |
|--|---|--|
| |  | |
|--|---|--|

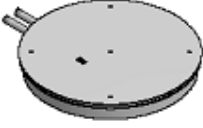
| | | |
|------------------------------|---|--|
| Code: 009880500100 |  | STATIONARY COLUMN INSTALLATION KIT FOR MAQUET TABLE |
|------------------------------|---|--|

Control devices

| | | |
|-------------------------|--|--|
| Code: 8805012 |  | RETRO ILLUMINATED WIRED CONTROL UNIT FOR VANTO The remote control unit is universal and allows to move all the operating table tops and columns of the Vanto operating system. It is protected by a shockproof casing and non-slip. |
|-------------------------|--|--|





| | | |
|-------------------------|---|--|
| Code: 8805A22 |  | I.R. RETRO ILLUMINATED REMOTE CONTROL FOR VANTO COMPLETE WITH CHARGING STATION The remote control is universal and allows to move all the operating table tops and the columns of the operating system Vanto. It is protected by an antishock and anti slip case. |
|-------------------------|---|--|

| | | |
|-------------------------|---|--|
| Code: 8800025 |  | VANTO WIRELESS REMOTE CONTROL WITH DISPLAY AND BATTERY CHARGER It is universal and allows to control available operating table top and the column of the operating system VANTO. The remote control has an impact resistant casing and antislip protection. |
|-------------------------|---|--|

| | | |
|-------------------------|---|--|
| Code: 9927019 |  | FOOT SWITCH 3 PEDALS FOR VANTO It drives three electrical movements; the standard one are the high adjustment of the column, the Trendel/reverse Trendel and the lateral tilt of the table top. But you can change them at your choice. |
|-------------------------|---|--|

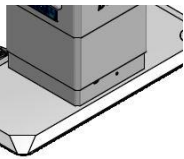
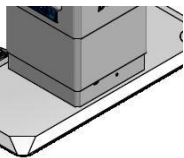
| | | |
|-------------------------|---|---|
| Code: 9927053 |  | JOYSTICK CONTROL FOR X and XY VANTO CARBON FIBRE VASCULAR TABLE TOP Joystick ergonomic and friendly-using with a gradual adjustment of the speeding and with the possibility of driving the movements for both vascular carbon fibre table top and Vanto column. It can be attached to the accessory rail and included the security button for avoiding accidental movements and/or not requested. |
|-------------------------|---|---|

Optional accessories

| | | |
|---------------------------------|---|--|
| <p>Code: 9920028</p> |  | <p>CLEANING TROLLEY FOR VANTO COLUMN Trolley to lift column and clean thoroughly underneath the base.</p> |
| <p>Code: 8802A</p> |  | <p>ANTICOLLISION SYSTEM FOR VANTO OUTER CASING for already installed tables The very innovative anti-collision system for the telescopic column foils (on the base of the column) permits to avoid that eventual objects (stools, trolleys, etc.) located beside the column, could damage or broken the foils, which protect the whole internal system, in case of collision.</p> |
| <p>Code: 8802AI</p> |  | <p>ANTICOLLISION SYSTEM FOR VANTO OUTER CASING to be installed tables The very innovative anti-collision system for the telescopic column foils (on the base of the column) permits to avoid that eventual objects (stools, trolleys, etc.) located beside the column, could damage or broken the foils, which protect the whole internal system, in case of collision.</p> |
| <p>Code: 9927026</p> |  | <p>OPT ACCESS POINT FOR STORZ "OR1" INTEGRATION It is the interface wireless device among the Integration Systems of the operating theatre.</p> |
| <p>Code: 9927043</p> |  | <p>OPT ACCESS POINT FOR OLYMPUS INTEGRATION Device for the wireless two way communication between the operating system and the Olympus Integration System (which connects directly to the Olympus Device). It is necessary to apply on the column the Integration Kit for column Vanto code 8802I (or code 8803I for column Vanto Plus or code 7702I for Asso column)</p> |
| <p>Code: 9927044</p> |  | <p>OPT ACCESS POINT FOR OPT INTEGRATION WITH TOUCH SCREEN CONSOLE Device for the wireless two way communication between the operating system and the external OPT Touch Screen code 9927028 or Integration Systems for operating theatres. It is necessary to apply on the column the Integration Kit for column Vanto code 8802I (or code 8803I for column Vanto Plus or code 7702I for Asso column)</p> |
| <p>Code: 8802I</p> |  | <p>VANTO STATIONARY AND MOBILE COLUMN INTEGRATION KIT - predisposition of the table The VANTO mobile column integration KIT could be installed on all columns (mobile and stationary version). It allows to install on the operating table all necessary components needed to connect the Vanto system to the network of a new generation integrated operating room.</p> |

| | | |
|---------------------------------|---|---|
| <p>Code: 8803I</p> |  | <p>VANTO "PLUS" COLUMN INTEGRATION KIT - predisposition of the table The VANTO Plus column integration kit could be installed on all columns (Plus version). It allows to install on the operating table all necessary components needed to connect the Vanto system to the network of a new generation integrated operating room.</p> |
| <p>Code: 9927034</p> |  | <p>MPC EMERGENCY DEVICE AND FOR THE ELECTRICAL MOVEMENT OF THE TABLE TOP ON THE TROLLEY It is an exclusive device for emergency, which can be used in case of fault of the control unit of the operating table and allows the moving of the table top, positioned on the trolley.</p> |
| <p>Code: 8811C</p> |  | <p>CONNECTORS KIT FOR MPC VANTO Connectors kit to be used on Vanto table tops, codes 8811000/8811000P and 8821000/8821000P, necessary for using the MPC device code 9927034 that allows the movement of the table top on the trolley.</p> |
| <p>Code: 8812C</p> |  | <p>KIT FOR SETTING UP OF CONNECTORS FOR VANTO TABLE TOPS (code 8812000/8812000P, 8822000/8822000P and 8815000), to use electric elongation plates (code 9933052/9933052P/9933058/9933058P) and MPC devices (code 9927034)</p> |
| <p>Code: 9927C</p> |  | <p>MPC CABLE CONNECTION - VANTO COLUMN Connection wire for the connecting of the emergency system MPC to the OPT Vanto column</p> |
| <p>Code: 9927035</p> |  | <p>EPS - EMERGENCY POWER SUPPLY DEVICE FOR VANTO Emergency device for the power supply of the operating system in case of uncharged batteries or power supply failure. It is necessary to apply on the column the connector kit EPS/MPC code 8802M (one kit for each column)</p> |
| <p>Code: 8802M</p> |  | <p>CONNECTION KIT FOR EPS/MPC VANTO CONNECTION To offer together with the MPC device code 9927034 and the EPS device code 9927035.</p> |

| | | |
|----------------------------------|---|---|
| <p>Code: 8811000</p> |  | <p>UNIVERSAL MODULAR TABLE TOP VANTO Operating table top universal and exchangeable with electro-mechanical movements, with modular central section, equipped with easily removable, radiolucent and antistatic cushion. The head section, legs section and the elongation plates (upper and low back sections) are not included and shall be ordered separately.</p> |
| <p>Code: 8811000P</p> |  | <p>OPERATING TABLE VANTO WITH VISCOELASTIC CUSHIONS Operating table top universal and exchangeable with electro-hydraulic movements, with modular central section, equipped with soft viscoelastic, easily removable, radiolucent and antistatic cushion. The head section, legs section and the elongation plates (upper and low back sections) are not included and shall be ordered separately.</p> |
| <p>Code: 8821000</p> |  | <p>VANTO UNIVERSAL TABLE TOP Universal transferable table top with electromechanical movements and with modular central section with integrated lower back section (length 300 mm). Complete with removable, radiolucent and electro-conductive cushions. Table top is without the head, leg sections and elongation plates (upper back sections). Sections can be ordered separately.</p> |
| <p>Code: 8821000P</p> |  | <p>VANTO UNIVERSAL TABLE TOP WITH INTEGRATED LOWER BACK SECTION AND CUSHIONS IN VISCOELASTIC MATERIAL Universal transferable operating table with electromechanic movements. The modular centre part comes without head section, back sections or leg sections but complete with soft viscoelastic radio transparent, antistatic, and removable.</p> |
| <p>Code: 8812000</p> |  | <p>UNIVERSAL MODULAR OPERATING TABLE TOP VANTO Operating table top universal and exchangeable with electro-mechanical movements, with modular and symmetrical central section, equipped with easily removable, radiolucent and antistatic cushion. The head section, legs section and the elongation plates (upper and low back sections) are not included and shall be ordered separately.</p> |
| <p>Code: 8812000P</p> |  | <p>UNIVERSAL TABLE TOP VANTO WITH VISCOELASTIC CUSHIONS Operating table top universal and exchangeable with electro-hydraulic movements, with modular and symmetrical central section, equipped with soft viscoelastic, easily removable, radiolucent and antistatic cushion. The head section, legs section and the elongation plates (upper and low back sections) are not included and shall be ordered separately.</p> |
| <p>Code: 8822000</p> |  | <p>UNIVERSAL TABLE TOP VANTO WITH INTEGRATED LOWER BACK SECTION Universal transferable table top with electromechanical movements and central section with integrated lower back section (length 300 mm). Complete with removable, radiolucent and electro-conductive cushions. Table top is without the head, leg sections and elongation plates (upper back sections). Sections can be ordered separately.</p> |

| | | |
|---------------------------------|---|---|
| <p>Code: 882200P</p> |  | <p>VANTO UNIVERSAL TABLE TOP WITH INTEGRATED LOWER BACK SECTION AND CUSHIONS IN VISCOELASTIC MATERIAL Universal transferable table top with electromechanical movements and central section with integrated lower back section (length 300 mm). Complete with removable, radiolucent and electro-conductive cushions in viscoelastic material. Table top is without the head, leg sections and elongation plates (upper back sections). Sections can be ordered separately.</p> |
| <p>Code: 8815000</p> |  | <p>ORTHOPEDIC OPERATING TABLE TOP VANTO The Vanto orthopedic table top comes without head and leg sections, but with radiotransparent cushion which is easily removable for hygienic and cleaning reasons. The cushion has a standard height of 60mm but can be personalized on request. The operating table is built entirely using high quality stainless steel for long operating room life.</p> |
| <p>Code: 8830000</p> |  | <p>CARBON FIBRE VASCULAR TABLE TOP FOR VANTO Carbon fibre vascular table top in a single section, with viscoelastic, memory foam, radiolucent and electrically conductive cushion, which is easily removable and with a minimum height of 80 mm. It can be completed with a removable head section (optional, to be ordered separately) which is entirely radiolucent. This vascular table top has an exceptional and totally electro-mechanical longitudinal slide of 700 mm.</p> |
| <p>Code: 8833000</p> |  | <p>CARBON FIBRE VASCULAR TABLE TOP X-Y FOR VANTO Carbon fibre vascular table top in a single section, with viscoelastic, memory foam, radiolucent and electrically conductive cushion, which is easily removable and with a minimum height of 80 mm. It can be completed with a removable head section (optional, to be ordered separately) which is entirely radiolucent. This vascular table top has an exceptional and totally electro-mechanical longitudinal slide of 700 mm and a bilateral translation of +/-105 mm, two movements that can be done simultaneously.</p> |
| <p>Code: 8899000</p> |  | <p>PULMONARY TABLE TOP VANTO The pulmonary table top VANTO is a specific table top for lung surgery</p> |

Elongation sections

| | | |
|----------------------------------|---|--|
| <p>Code: 9923076</p> |  | <p>CARBON SUPPORT FOR PERCUTANEOUS SURGERY WITH UNIQUE "FIX TORQUE" LOCKING SYSTEM Shaped carbon fibre support for percutaneous surgery. Complete with accessory side rails 25x10 mm to sustain the direct placement stirrups. Completely 360° radiolucent for a 405 mm line. It has a 50 mm high cushion. To be completed with direct placement stirrups. Dimension: 595x530 mm (590 mm side rails included) Weight: 13 kg</p> |
| <p>Code: 9933023</p> |  | <p>PLATE WITH SIDE RAILS FOR VANTO VASCULAR TABLE TOP AND XY TABLE TOP VANTO Radiolucent, with side rails. To be used with VANTO vascular table top and Vanto X/Y vascular table top. Dimension: 150x597 mm (639 mm side rails included) Weight: 3 kg</p> |
| <p>Code: 9933052</p> |  | <p>ELECTRIC ELONGATION PLATE FOR VANTO LENGTH 300 MM WITH UNIQUE "FIX-TORQUE" LOCKING SYSTEM Complete with radiolucent and antistatic cushion. Dimension: 340x530 mm (590 mm side rails included) Weight: 18 kg</p> |
| <p>Code: 9933052P</p> |  | <p>ELECTRIC ELONGATION PLATE FOR VANTO WITH VISCOELASTIC CUSHIONS - LENGTH 300 MM AND WITH UNIQUE "FIX-TORQUE" LOCKING SYSTEM Motorized elongation plate, complete with integrated soft viscoelastic cushions with shape memory, radiolucent and antistatic, easily removable, with a minimum thickness of 80 mm. for a comfortable decubitus of the patient, even during long interventions. Dimension: 340x530 mm (590 mm side rails included) Weight: 18 kg</p> |
| <p>Code: 9933053</p> |  | <p>ELONGATION PLATE LENGTH 300 MM WITH UNIQUE "FIX-TORQUE" LOCKING SYSTEM Complete with radiolucent and antistatic cushion. Dimension: 300x530 mm (590 mm side rails included) Weight: 9 kg</p> |
| <p>Code: 9933053P</p> |  | <p>ELONGATION PLATE WITH VISCOELASTIC CUSHIONS - LENGTH 300 MM. AND WITH UNIQUE "FIX-TORQUE" LOCKING SYSTEM FOR ASSO, CENTURY, VITA, VANTO Complete with integrated soft viscoelastic, radiolucent, antistatic and easily removable cushion with shape memory (minimal thickness mm. 80) for a comfortable decubitus of the patient, even during long interventions. Dimension: 300x530 mm (590 mm side rails included) Weight: 10 kg</p> |

| | | |
|----------------------------------|---|--|
| <p>Code: 9933054</p> |  | <p>MANUALLY TILTABLE ELONGATION PLATE WITH PERINEAL CUT - LENGTH 300 MM WITH UNIQUE "FIX-TORQUE" LOCKING SYSTEM Complete with radiolucent and antistatic cushion.</p> <p>Dimension: 300x530 mm (590 mm side rails included) Weight: 11 kg</p> |
| <p>Code: 9933054P</p> |  | <p>MANUALLY TILTABLE ELONGATION PLATE WITH VISCOELASTIC CUSHIONS AND WITH PERINEAL CUT - LENGTH 300 MM AND WITH UNIQUE "FIX-TORQUE" LOCKING SYSTEM Complete with integrated soft viscoelastic, radiolucent, antistatic and easily removable cushions with shape memory (minimal thickness mm. 80) for a comfortable decubitus of the patient, even during long interventions.</p> <p>Dimension: 300x530 mm (590 mm side rails included) Weight: 12 kg</p> |
| <p>Code: 9933055</p> |  | <p>ELONGATION PLATE 250 MM. WITH UNIQUE "FIX-TORQUE" LOCKING SYSTEM Complete with radiolucent and antistatic cushion.</p> <p>Dimension: 250x530 mm (590 mm side rails included) Weight: 7 kg</p> |
| <p>Code: 9933055P</p> |  | <p>ELONGATION PLATE WITH VISCOELASTIC CUSHION - LENGTH 250 MM AND WITH UNIQUE "FIX-TORQUE" LOCKING SYSTEM FOR ASSO, CENTURY, VITA, VANTO Complete with integrated soft viscoelastic, radiolucent, antistatic and easily removable cushions with shape memory (minimal thickness mm. 80) for a comfortable decubitus of the patient, even during long interventions.</p> <p>Dimension: 250x530 mm (590 mm side rails included) Weight: 8 kg</p> |
| <p>Code: 9933057</p> |  | <p>ELONGATION PLATE WITH PERINEAL CUT - LENGTH 300 MM WITH UNIQUE "FIX-TORQUE" LOCKING SYSTEM Complete with radiolucent and antistatic cushion.</p> <p>Dimension: 300x530 mm (590 mm side rails included) Weight: 9 kg</p> |
| <p>Code: 9933057P</p> |  | <p>ELONGATION PLATE WITH VISCOELASTIC CUSHIONS AND PERINEAL CUT - LENGTH 300 MM AND WITH UNIQUE "FIX-TORQUE" LOCKING SYSTEM Complete with integrated soft viscoelastic, radiolucent, antistatic and easily removable cushions with shape memory (minimal thickness mm. 80) for a comfortable decubitus of the patient, even during long interventions.</p> <p>Dimension: 300x530 mm (590 mm side rails included) Weight: 9 kg</p> |

| | | |
|----------------------------------|---|---|
| <p>Code: 9933058</p> |  | <p>ELECTRIC ELONGATION PLATE FOR VANTO WITH PERINEAL CUT AND WITH UNIQUE "FIX-TORQUE" LOCKING SYSTEM Complete with radiolucent and antistatic cushion. Dimension: 340x530 mm (590 mm side rails included) Weight: 18 kg</p> |
| <p>Code: 9933058P</p> |  | <p>ELECTRIC ELONGATION PLATE FOR VANTO WITH VISCOELASTIC CUSHION, PERINEAL CUT AND WITH UNIQUE "FIX-TORQUE" LOCKING SYSTEM Motorized elongation plate, equipped with integrated soft viscoelastic cushions with shape memory, radiolucent and antistatic, easily removable, with a minimum thickness of 80 mm. for a comfortable decubitus of the patient, even during long interventions. Dimension: 340x530 mm (590 mm side rails included) Weight: 18 kg</p> |
| <p>Code: 9933059</p> |  | <p>TILTABLE ELONGATION PLATE mm. 300 WITHOUT PERINEAL CUT AND WITH UNIQUE "FIX-TORQUE" LOCKING SYSTEM Complete with radiolucent and antistatic cushion. The manual folding allows the movements of + 60°/-95°. The adjustment handle rotation for a 360° Dimension: 300x530 mm (590 mm side rails included) Weight: 11 kg</p> |
| <p>Code: 9933062</p> |  | <p>ELONGATION PLATE WITH LUMBAR ADJUSTMENT AND WITH UNIQUE "FIX-TORQUE" LOCKING SYSTEM Elongation plate with crank handle ram, for lumbar adjusting of the patient in thorax flex position, through a vertical movement of 50 mm. Complete with antistatic cushion. Dimension: 250x530 mm (590 mm side rails included) Weight: 10 kg</p> |
| <p>Code: 9933062P</p> |  | <p>ELONGATION PLATE WITH LUMBAR ADJUSTMENT AND VISCOELASTIC CUSHIONS AND WITH UNIQUE "FIX-TORQUE" LOCKING SYSTEM Elongation plate with crank handle ram, for lumbar adjusting of the patient in thorax flex position, through a vertical movement of 50 mm. Complete with integrated soft viscoelastic, radiolucent, antistatic and easily removable cushion with shape memory (minimal thickness mm. 80) for a comfortable decubitus of the patient, even during long interventions. Dimension: 250x530 mm (590 mm side rails included) Weight: 10 kg</p> |

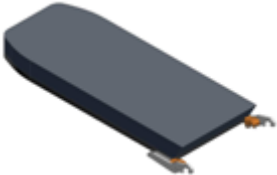

| | | |
|----------------------------------|---|---|
| <p>Code: 9933063</p> |  | <p>PAEDIATRIC RADIOLUCENT BACK SECTION WITH UNIQUE "FIX-TORQUE" LOCKING SYSTEM Pediatric back section radiolucent 360° in carbon fibre, complete with radiolucent and antistatic cushion. Dimension: 936x480 mm (542 mm side rails included) Weight: 14 kg</p> |
| <p>Code: 9907063</p> |  | <p>TRAPEZOIDAL BACK SECTION ELONGATION WITH UNIQUE "FIX-TORQUE" LOCKING SYSTEM Complete with radiolucent and antistatic cushion. To be used with connecting bar (code 9905038 or 9908025) and head rest to be ordered separately. Dimension: 442x498 mm (549 mm side rails included) Weight: 8 kg</p> |
| <p>Code: 9907063P</p> |  | <p>TRAPEZOIDAL ELONGATION SECTION WITH VISCOELASTIC CUSHIONS AND WITH UNIQUE "FIX-TORQUE" LOCKING SYSTEM FOR ASSO, CENTURY, VITA AND VANTO Complete with integrated soft viscoelastic, radiolucent, antistatic and easily removable cushions with shape memory (minimal thickness mm. 80) for a comfortable decubitus of the patient, even during long interventions. To be used with connecting bar (code 9905038 or 9908025) and head rest to be ordered separately. Dimension: 442x497 mm (548 mm side rails included) Weight: 8 kg</p> |
| <p>Code: 9907078</p> |  | <p>SUPPORTING BAR FOR ELONGATION SECTIONS Supporting bar (25 X 10 mm.) to be attached to the side rails of the head sections of Vanto, Asso, Century, Vita . Dimension: 160x590 mm</p> |

Carbon fibre back section

| | | |
|----------------------------------|---|--|
| <p>Code:</p> |  | <p>CARBON FIBRE BACK SECTION LENGTH 1200 MM WITH UNIQUE "FIX-TORQUE" LOCKING SYSTEM Radiolucent section, complete with radiolucent and antistatic cushion. Dimension: 1295x480 mm Weight: 15 kg</p> |
| <p>Code: 9933060P</p> |  | <p>CARBON FIBRE BACK SECTION 1200MM WITH VISCOELASTIC CUSHIONS AND WITH UNIQUE "FIX-TORQUE" LOCKING SYSTEM Complete with integrated soft viscoelastic, radiolucent, antistatic and easily removable cushion with shape memory (minimal thickness mm. 80) for a comfortable decubitus of the patient, even during long interventions. Dimension: 1295x480 mm Weight: 16 kg</p> |

Head Section

| | | |
|---------------------------------|---|---|
| <p>Code: 9905054</p> |  | <p>RECLINABLE HEAD SECTION WITH UNIQUE "FIX-TORQUE" LOCKING SYSTEM complete with integrated cushion, antistatic and radiolucent. Dimension: 281x398 mm (590 mm side rails included) Weight: 6 kg</p> |
|---------------------------------|---|---|

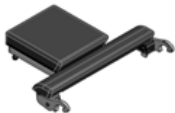
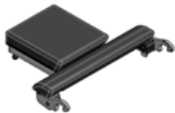
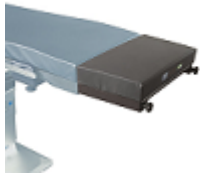
| | | |
|----------------------------------|---|--|
| <p>Code: 9905054P</p> |  | <p>TILTABLE HEAD SECTION WITH VISCOELASTIC CUSHIONS AND WITH UNIQUE "FIX-TORQUE" LOCKING SYSTEM FOR ASSO, CENTURY, VITA, VANTO Complete with integrated soft viscoelastic, radiolucent, antistatic and easily removable cushion with shape memory (minimal thickness mm. 80) for a comfortable decubitus of the patient, even during long interventions.</p> <p>Dimension: 281x397 mm (590 mm side rails included) Weight: 6 kg</p> |
| <p>Code: 9905055</p> |  | <p>HEAD SECTION WITH DOUBLE MICROMETRIC ADJUSTMENT WITH UNIQUE "FIX-TORQUE" LOCKING SYSTEM Complete with integrated cushion, radiolucent and antistatic.</p> <p>Dimension: 281x398 mm (590 mm side rails included) Weight: 8 kg</p> |
| <p>Code: 9905055P</p> |  | <p>HEAD SECTION WITH DOUBLE ADJUSTMENT WITH VISCOELASTIC CUSHIONS AND WITH UNIQUE "FIX-TORQUE" LOCKING SYSTEM FOR ASSO, CENTURY, VITA, VANTO Complete with integrated soft viscoelastic, radiolucent, antistatic and easily removable cushion with shape memory (minimal thickness mm. 80) for a comfortable decubitus of the patient, even during long interventions.</p> <p>Dimension: 281x397 mm (590 mm side rails included) Weight: 8 kg</p> |
| <p>Code: 9905056</p> |  | <p>HEAD SECTION FOR ENT SURGERY WITH UNIQUE "FIX-TORQUE" LOCKING SYSTEM Complete with integrated cushion, radiolucent and antistatic.</p> <p>Dimension: 432x530 mm Weight: 7 kg</p> |
| <p>Code: 9905056P</p> |  | <p>HEAD SECTION FOR ENT SURGERY WITH VISCOELASTIC CUSHIONS AND WITH UNIQUE "FIX-TORQUE" LOCKING SYSTEM Complete with integrated soft viscoelastic, radiolucent, antistatic and easily removable cushion with shape memory (minimal thickness mm. 80) for a comfortable decubitus of the patient, even during long interventions.</p> <p>Dimension: 432x530 mm Weight: 7 kg</p> |
| <p>Code: 9905068</p> |  | <p>HEADREST FOR VASCULAR AND XY VANTO TABLE TOP Removable, complete with soft, radiolucent and antistatic cushion, comfortable for the decubitus of the patient. For VANTO vascular table top - codes 8830000-8833000.</p> <p>Dimension: 300x550 mm Weight: 6 kg</p> |

| | | |
|----------------------------------|--|--|
| <p>Code: 9905070</p> |  | <p>HEAD SECTION WITH SINGLE UNHOOK WITH UNIQUE "FIX-TORQUE" LOCKING SYSTEM Headrest for Asso and Vanto tables with single unhook system and micrometric adjustment to the angle of the neck of the patient, complete with integrated radiolucent, antistatic and easily removable cushion. Dimension: 281x398 mm (590 mm side rails included) Weight: 8 kg</p> |
| <p>Code: 9905070P</p> |  | <p>HEAD SECTION WITH SINGLE UNHOOK WITH VISCOELASTIC CUSHIONS AND WITH UNIQUE "FIX-TORQUE" LOCKING SYSTEM FOR ASSO, CENTURY, VITA, VANTO Headrest with single unhook system and micrometric adjustment to the angle of the neck of the patient, complete with integrated soft viscoelastic, radiolucent, antistatic and easily removable cushion with shape memory (minimal thickness mm. 80) for a comfortable decubitus of the patient, even during long interventions. Dimension: 281x397 mm (590 mm side rails included) Weight: 8 kg</p> |
| <p>Code: 9905071</p> |  | <p>RECLINABLE HEADREST FOR VANTO VASCULAR TABLE TOP AND XY TABLE TOP Removable and complete with integrated removable soft cushion, which is radiolucent, antistatic, viscoelastic and memory foam with a minimum thickness of 80 mm for a comfortable patient positioning even during long procedures. Dimension: 297x550 mm</p> |

Leg section



| | | |
|----------------------------------|---|--|
| <p>Code: 9930060</p> |  | <p>LEG SECTION IN TWO PARTS WITH UNIQUE "FIX-TORQUE" LOCKING SYSTEM FOR ASSO, CENTURY, VITA AND VANTO Leg section can be spread with double movement opening. Complete with integrated cushions, radiolucent, antistatic with a thickness of 80 mm for a comfortable decubitus of the patient during the long lasting interventions. Dimension: 780x532 mm (590 mm side rails included) Weight: 13.4 kg</p> |
| <p>Code: 9930060P</p> |  | <p>LEG SECTION IN TWO PARTS WITH VISCOELASTIC CUSHIONS AND WITH UNIQUE "FIX-TORQUE" LOCKING SYSTEM FOR ASSO, CENTURY, VITA AND VANTO Leg section can be spread with double movement opening. Complete with integrated removable viscoelastic cushions, radiolucent and antistatic. Dimensions: 780x529 mm (590 mm side rails included) Weight: 13.4 kg</p> |

| | | |
|----------------------------------|---|---|
| <p>Code: 9930051</p> |  | <p>LEG SECTION IN FOUR PARTS WITH DOUBLE SPREAD WITH UNIQUE "FIX-TORQUE" LOCKING SYSTEM Complete with radiolucent and antistatic cushions. Dimension: 780x530 mm (590 mm side rails included) Weight: 20 kg</p> |
| <p>Code: 9930051P</p> |  | <p>LEG SECTION IN FOUR PARTS WITH DOUBLE SPREAD, WITH VISCOELASTIC CUSHIONS AND WITH UNIQUE "FIX-TORQUE" LOCKING SYSTEM Complete with integrated soft viscoelastic, radiolucent, antistatic and easily removable cushions with shape memory (minimal thickness mm. 80) for a comfortable decubitus of the patient, even during long interventions. Dimension: 780x530 mm (590 mm side rails included) Weight: 22 kg</p> |
| <p>Code: 9930059P</p> |  | <p>REMOVABLE LEG SECTION IN FOUR PARTS WITH DOUBLE SPREAD WITH VISCOELASTIC CUSHIONS AND WITH UNIQUE FIX TORQUE LOCKING SYSTEM Complete with viscoelastic, radiolucent, antistatic and easily removable cushion with shape memory (minimal thickness mm. 80) for a comfortable decubitus of the patient, even during long interventions. Dimensions: 864x528 mm (590 mm side rails included) Weight: 18 kg</p> |
| <p>Code: 9930053</p> |  | <p>LIGHT SINGLE PART LEG SECTION WITH UNIQUE "FIX-TORQUE" ATTACHMENT SYSTEM Complete with antistatic, radiolucent and electro-conductive cushions. Length: 864 mm. Dimension: 780x530 mm Weight: 9 kg</p> |
| <p>Code: 9930053P</p> |  | <p>SINGLE PART LEG SECTION WITH VISCOELASTIC CUSHIONS AND UNIQUE "FIX-TORQUE" ATTACHMENT SYSTEM FOR ASSO, CENTURY, VITA, VANTO Single part leg section with radiolucent, antistatic, easily removable cushion in viscoelastic material. Memorizes the position and has a thickness of minimum 80 mm. For maximum comfort of the patient even during long lasting operating sessions. Dimension: 780x530 mm Weight: 12 kg</p> |
| <p>Code: 9930056</p> |  | <p>REMOVABLE LEG SECTION IN FOUR PARTS WITH UNIQUE "FIX-TORQUE" LOCKING SYSTEM Complete with radiolucent and antistatic cushions. Dimension: 775x530 mm (590 mm side rails included) Weight: 18 kg</p> |

| | | |
|----------------------------------|---|--|
| <p>Code: 9930056P</p> |  | <p>REMOVABLE LEG SECTION IN FOUR PARTS WITH DOUBLE SPREAD WITH VISCOELASTIC CUSHIONS AND WITH UNIQUE "FIX-TORQUE" LOCKING SYSTEM Complete with integrated soft viscoelastic, radiolucent, antistatic and easily removable cushion with shape memory (minimal thickness mm. 80) for a comfortable decubitus of the patient, even during long interventions. Dimension: 775x530 mm (590 mm side rails included) Weight: 21 kg</p> |
| <p>Code: 9930057</p> |  | <p>ULTRA-LIGHT SINGLE PART LEG SECTION WITH CLOTH WITH UNIQUE "FIX-TORQUE" LOCKING SYSTEM Dimension: 804x550 mm Weight: 4 kg</p> |
| <p>Code: 9930057P</p> |  | <p>ULTRA-LIGHT SINGLE PART LEG SECTION WITH CLOTH WITH VISCOELASTIC CUSHIONS AND WITH UNIQUE "FIX-TORQUE" LOCKING SYSTEM Dimension: 804x550 mm Weight: 6 kg</p> |

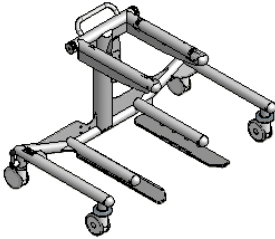
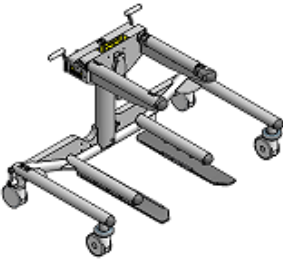
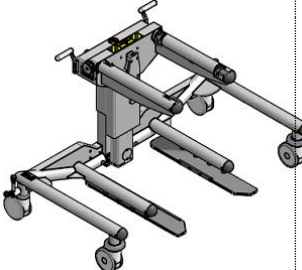
Trolley for the transport of table top or of Vanto column+table top:

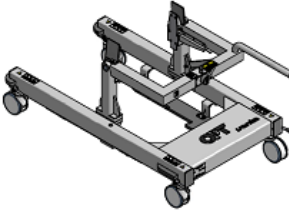
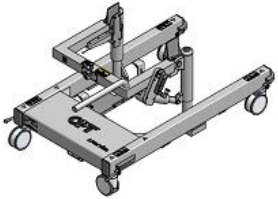
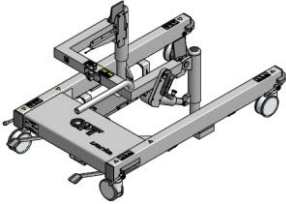
| | | |
|---------------------------------|---|---|
| <p>Code: 8840000</p> |  | <p>LATERAL TROLLEY FOR VANTO Trolley for the transporting of the table tops with lateral insertion, it means it is possible to insert it into the column indifferently from right and left side. It is made of a strong high quality stainless steel and equipped with four big wheels (125 mm. in diameter). Two of them can be blocked in longitudinal direction, braked, or be free to rotate 360 degrees.</p> |
| <p>Code: 8850000</p> |  | <p>LATERAL TROLLEY WITH TREND/REVERSE TRENDENBURG FOR VANTO Trolley for the transporting of the table tops with lateral insertion, it means it is possible to insert the column indifferently from the right and left side, with Trendelenburg/Reverse Trendelenburg movement. It is made of a strong high quality stainless steel and equipped with four big wheels (125 mm. in diameter). Two of them can be blocked in longitudinal direction, braked, or be free to rotate 360 degrees.</p> |
| <p>Code: 8860000</p> |  | <p>LATERAL TROLLEY WITH HEIGHT ADJUSTEMENT AND TREND/REVERSE TRENDENBURG FOR VANTO Trolley for the transport of the table tops with lateral insertion, it means it is possible to insert it into the column indifferently from the right and left side, with Trendelenburg/Reverse Trendelenburg movement and height adjustment movement. It is made of a strong high quality stainless and equipped with four big wheels (125 mm. in diameter). Two of them can be blocked in longitudinal direction, braked, or be free to rotate 360 degrees.</p> |

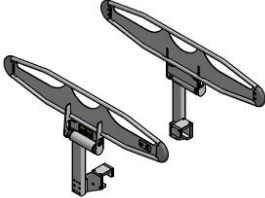

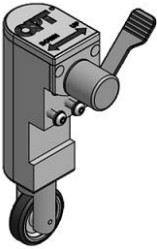



| | | |
|----------------------------------|---|--|
| <p>Code: 6874000</p> |  | <p>LONGITUDINAL TROLLEY (HEAD/FEET ACCESS TO THE COLUMN) FOR VANTO The trolley for the transport of the table top is entirely made of stainless steel and high quality materials. It is provided of four big wheels (diameter 125 mm.), that can be blocked/braked o let be free to rotate 360°.</p> |
| <p>Code: 6884000</p> |  | <p>LONGITUDINAL TROLLEY FOR SYSTEM VANTO WITH TRENDELENBURG/REVERSE TRENDELENBURG The trolley for the transport of the table top, with longitudinal insertion (head/feet) and Trendelenburg/reverse Trendelenburg movement, is entirely made of stainless steel and high quality materials. It is provided of four big wheels (diameter 125 mm.), that can be blocked/braked o let be free to rotate 360°.</p> |
| <p>Code: 6894000</p> |  | <p>LONGITUDINAL TROLLEY FOR VANTO SYSTEM WITH TRENDELENBURG/REVERSE TRENDELBURG AND ADJUSTABLE HEIGHT The trolley for the transport of the table top with longitudinal insertion (head/feet) Trendelenburg/reverse Trendelenburg movement and height adjustment is entirely made of stainless steel and high quality materials. It is provided of four big wheels (diameter 125 mm.), that can be blocked/braked o let be free to rotate 360°.</p> |
| <p>Code: 6894000X</p> |  | <p>LONGITUDINAL TROLLEY FOR VANTO SYSTEM WITH VASCULAR TABLE TOP TYPE "X" WITH TRENDELENBURG, REVERSE TRENDELENBURG AND ADJUSTABLE HEIGHT Trolley with longitudinal insertion (head/leg side) and with the movements of Trendelenburg / Reverse Trendelenburg and adjustable height for the transporting of the system VANTO with vascular table top code 8830000. The trolley is made of electro-polished stainless steel and is equipped with 4 wheels of 125 mm diameter which can be blocked or moved and rotated at 360 degrees.</p> |
| <p>Code: 6894000Y</p> |  | <p>LONGITUDINAL TROLLEY FOR VANTO SYSTEM WITH VASCULAR TABLE TOP TYPE "XY" WITH TRENDELENBURG/REVERSE TRENDELENBURG AND ADJUSTABLE HEIGHT Trolley with longitudinal insertion (head/leg side) and with the movements of Trendelenburg / Reverse Trendelenburg and adjustable height for the transporting of the system VANTO with vascular table top code 8833000. The trolley is made of electro-polished stainless steel and is equipped with 4 wheels of 125 mm diameter which can be blocked or moved and rotated at 360 degrees.</p> |
| <p>Code: 9920036</p> |  | <p>LATERAL PATIENT PROTECTIONS (PAIR) FOR VANTO LONGITUDINAL TROLLEY Pair of lateral patient protections (foldable at 180°) to be used on Vanto trolleys code 6894000 - 6884000 - 6874000.</p> |

| | | |
|---------------------------------|---|---|
| <p>Code: 9920009</p> |  | <p>5TH WHEEL FOR VANTO LATERAL TROLLEYS</p> |
| <p>Code: 9920034</p> |  | <p>5TH WHEEL FOR CENTURY AND VANTO LONGITUDINAL TROLLEYS The 5th directional wheel can be inserted or removed easily and rapidly with a pedal. It ensures a better manoeuvrability of the trolley.</p> <p>Weight: ≈ 7.5 kg</p> |

ACCESSORIES FOR ANAESTHESIA

| | | |
|---------------------------------|---|---|
| <p>Code: 9903001</p> |  | <p>ANAESTHESIA SCREEN FOR OPT 20, 30/1 AND 40/1 Height and length adjustable, tiltable, with 2 lateral extension bars, with security system. Complete with clamps.</p> |
| <p>Code: 9903007</p> |  | <p>ANAESTHESIA SCREEN FOR CENTURY, VANTO AND ASSO Height and length adjustable, tiltable, with 2 lateral extension bars, with security system. Complete with clamps.</p> |
| <p>Code: 9903003</p> |  | <p>L-SHAPED ANAESTHESIA SCREEN Height and length adjustable, tiltable, with rubber patient protection and security ring, complete with 2 lateral extension bars. Use with clamp to be ordered separately (advised code 9901023).</p> |
| <p>Code: 9903009</p> |  | <p>FLEXIBLE SCREEN With frame adjustable from 1.400 to 1.900 mm. Used with n. 2 clamps to be ordered separately.</p> |
| <p>Code: 9906801</p> |  | <p>SUSPENDED ARM STRAP Made of washable tissue, having 100 mm width to be attached to anaesthesia screen for the suspension of patient's arm. Advised quantity 2.</p> |
| <p>Code: 9914001</p> |  | <p>BODY/LEG STRAP Padded and washable belt, adjustable length, with security and breaking system. Completed with clamps. Width mm 60.</p> |

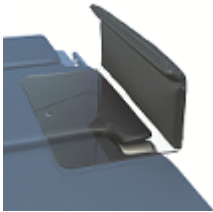
| | | |
|---------------------------------|---|---|
| <p>Code: 9914008</p> |  | <p>BODY/LEG STRAP FOR OBESE Padded and washable belt, adjustable length, with security and breaking system. Completed with clamps. Width 150 mm.</p> |
| <p>Code: 9914009</p> |  | <p>BODY/LEG STRAP WITH CLAMPS Width 100 mm and washable, with clips for attaching onto the side rails adjustable in its length. With anti fall system.</p> |
| <p>Code: 9914005</p> |  | <p>SINGLE LEG STRAP Advised for laparoscopic surgery. Washable, with velcro closure. Suitable for divided leg section. Complete with clip for attaching onto side rail. Advised quantity 2.</p> |
| <p>Code: 9914011</p> |  | <p>SINGLE LEG STRAP Washable, with velcro closure. Suitable for divided leg section. Advised quantity 2.</p> |
| <p>Code: 9914012</p> |  | <p>BODY / LEG STRAP WITH VELCRO CLOSURE With clips for attaching onto the side rails with locking system, detachable in two sections. Washable, width 100 mm.</p> |
| <p>Code: 9914013</p> |  | <p>PADDED BODY STRAP Fixing system for the patient in beach-chair position to the side rails of the back plate for shoulder surgery. Washable, length 1.900 mm and width on the padded point 150 mm.</p> |

| | | |
|----------------------------------|---|--|
| <p>Code: 9915001</p> |  | <p>LEATHER WRISTLET Washable, with velcro closure, padded and complete with clamp.</p> |
| <p>Code: 9915005</p> |  | <p>LEATHER WRISTLET FOR OBESES Washable, with velcro closure, padded and complete with clamp.</p> |
| <p>Code: 9915002</p> |  | <p>WRIST SUPPORT Completed with fast-frontal locking clamp to be placed onto side rail to keep the arm parallel to the body. Made of washable cotton, with velcro closure, length: 100 mm.</p> |
| <p>Code: 9915002P</p> |  | <p>WRIST SUPPORT FOR TABLE TOP WITH VISCOELASTIC CUSHIONS Completed with fast-frontal locking clamp to be placed onto side rail to keep the arm parallel to the body. Made on washable cotton, with velcro closure, length: 100 mm.</p> |
| <p>Code: 9915004</p> |  | <p>ARM PROTECTOR FOR ADULTS Acrylic material plate, easy to install, used for placement/protection of patient's arm. Length 400 mm and height 130 mm.</p> |
| <p>Code: 9915006</p> |  | <p>ARM PROTECTION PAEDIATRIC Acrylic material plate, easy and comfortable to install, used for placement/protection of patient's arm. Length 300 mm and height 100 mm.</p> |



| | | |
|----------------------------------|---|---|
| <p>Code: 9916002</p> |  | <p>INFUSION ROD Can be tilted to maintain the vertical position, height adjustable (from 800 mm to 1500 mm), complete with hooks and clamp.</p> |
| <p>Code: 9906012</p> |  | <p>PAEDIATRIC ARM SUPPORT Completed with clamp for frontal and fast locking, with a soft cushion, and two fixation belts.</p> |
| <p>Code: 9906021</p> |  | <p>ARM SUPPORT FOR ADULTS ON BALL JOINT FOR OPT 30/1-40/1-VANTO-ASSO-CENTURY Complete with frontal fast locking clamp, a soft cushion, and two fixation belts. Dimension: 510 x 140 mm.</p> |
| <p>Code: 9906021P</p> |  | <p>ARM SUPPORT WITH VISCOELASTIC CUSHIONS FOR OPT 30/1 - 40/1 - ASSO - VANTO - CENTURY Complete with clamp for frontal and fast locking, a soft cushion, and two fixation belts.</p> |
| <p>Code: 9906026</p> |  | <p>ARM SUPPORT - LONGITUDINALLY AND HEIGHT ADJUSTABLE Complete with clamp for frontal and fast locking, a soft cushion with dimensions 510 mm x 140 mm, and two fixation belts. Height adjustable for 290 mm and longitudinally adjustable for 300 mm.</p> |
| <p>Code: 9906028</p> |  | <p>ARM SUPPORT WITH TRIPLE JOINT FOR PATIENTS IN LATERAL DECUBITUS For patient in lateral decubitus. Complete with frontal fast locking clamp, soft cushion and a fixation belt. Dimensions: 400 x150 mm.</p> |
| <p>Code: 9906029</p> |  | <p>ARM SUPPORT FOR PARK BENCH POSITION WITH FAST LOCKING CLAMP For patient in park bench position, height adjustable for 459 mm. Complete with frontal fast locking clamp, soft cushion and a fixation belt. Dimension: 510 x140 mm.</p> |



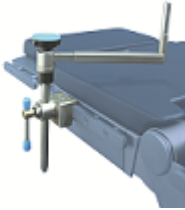

| | | |
|---------------------------------|---|--|
| <p>Code: 9906030</p> |  | <p>ARM SUPPORT ON BALL JOINT WITH LEVER Can be swivelled via ball-and-socket joint by a lever system with one hand. Height adjustable, completed with cushion with dimension 510 mm x 140 mm, two fixation belts, and frontal fast locking clamp.</p> |
| <p>Code: 9906032</p> |  | <p>ARM SUPPORT ON BALL JOINT Complete with an adjustment system with ball-and-socket joint to fix the support on all positions. It is height adjustable with a run of 100 mm, complete with cushion 510 x 140 mm and thickness 40 mm, two fixation belts, and frontal fast locking clamp.</p> |
| <p>Code: 9906013</p> |  | <p>ARM SUPPORT ON BALL JOINT Height adjustable for 150 mm. Complete with frontal fast locking clamp, soft cushion with dimension 510 mm x 140 mm, and two fixation belts.</p> |
| <p>Code: 9906019</p> |  | <p>ARM SUPPORT FOR OBESES - ON BALL JOINT Height adjustable for 150 mm, complete with frontal fast locking clamp, soft cushion, and two fixation belts. Dimensions: 500 x 248 mm.</p> |
| <p>Code: 9906003</p> |  | <p>ARM SUPPORT FOR PATIENT IN LATERAL DECUBITUS Swivelling via ball-and-socket joint, height adjustable for 600 mm. Completed with soft cushion with dimensions 400 mm x 150 mm and belts. To be used with clamp to be ordered separately.</p> |
| <p>Code: 9907067</p> |  | <p>FLEXIBLE SUPPORT FOR ANAESTHESIA TUBES Flexible and completed with clamp.</p> |

| | | |
|----------------------------------|---|---|
| <p>Code: 9928003</p> |  | <p>RAILING LATERAL EDGE Made of stainless steel, can be tilted. Dimension 720 mm x 280 mm. Complete with fast locking clamp.</p> |
| <p>Code: C3103786</p> |  | <p>VACUUM MATTRESS Vacuum cushion to immobilise patients on operating tables, even with polytrauma.</p> |
| <p>Code: C3103787</p> |  | <p>PLASTIC LIFT PUMP FOR VACUUM MATTRESS To be used with Vacuum mattress codes C3103786 - C3103806 - C3103813. From 55 cm.</p> |
| <p>Code: C3103806</p> |  | <p>VACUUM MATTRESS Vacuum cushion to immobilise patients on operating tables, even with polytrauma. Dimension: 750 x1000 mm.</p> |

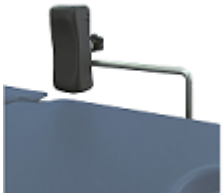
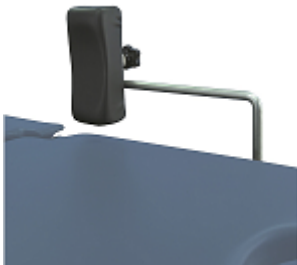
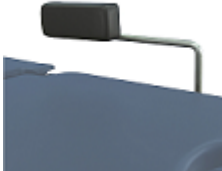

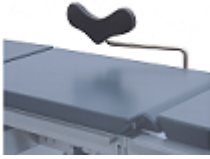



ACCESSORIES FOR GENERAL SURGERY

| | | | |
|-------------------------|---|--|----------------------------|
| Code: 9901007 |  | CONTROL UNIT SUPPORT FOR OPT 30/1 - 40/1 Support for hanging the control unit onto side rails (25 x 10 mm). | Price 2017 231,00 |
| Code: 9901023 |  | CLAMP WITH RADIAL SETTING AND FAST LOCKING ATTACHMENT For side rails of size 25x10mm. It can be used with rods of 16 mm and 18 mm diameter. It allows both fixation of the accessory to the clamp and clamp fixation onto the side rails by using a single knob. A 360° rotation of the accessory is allowed | Price 2017 264,00 |
| Code: 9904003 |  | PAIR OF ADJUSTABLE SHOULDER SUPPORTS With antistatic cushions and clamps. Height and width adjustable ± 160 mm. | Price 2017 952,00 |
| Code: 9909008 |  | PAIR OF ADJUSTABLE FEET SUPPORTS With antistatic cushions and clamps. Height and width adjustable ± 110 mm. | Price 2017 1.133,00 |
| Code: 9908009 |  | UNIVERSAL LATERAL SUPPORT Made of stainless steel, it can be used as universal fixture for body supports. Height adjustable ± 150 mm, complete with clamp. | Price 2017 329,00 |
| Code: 9908019 |  | UNIVERSAL LATERAL SUPPORT Made of stainless steel, it is used to fixed body supports. Swivelling and length (± 110 mm) and height (± 100 mm) adjustable. Complete with clamp. | Price 2017 635,00 |

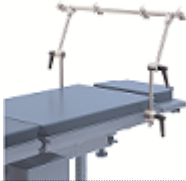
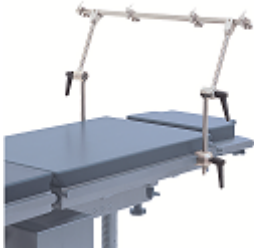
| | | |
|---------------------------------|---|--|
| <p>Code: 9908022</p> |  | <p>UNIVERSAL LATERAL SUPPORT Made of stainless steel, swivelling, length (± 110 mm) and height (± 175 mm) adjustable with radial toothed locking system. Complete with radial setting clamp with frontal fast locking attachment.</p> |
| <p>Code: 9908006</p> |  | <p>PUBIS SUPPORT Cushion (size 50 x 50 mm), complete with locking for universal support. To be used with universal lateral support 9908009-9908019-9908022 to be ordered separately.</p> |
| <p>Code: 9908001</p> |  | <p>STERNAL - BACK SUPPORT Cushion (size 120 x 100 mm) complete with locking for universal support. To be used with support code 9908009-9908019-9908022 to be ordered separately.</p> |
| <p>Code: 9908002</p> |  | <p>BACK BUTTOCKS SUPPORT Cushion complete with locking for universal support. It can be mounted either horizontally or vertically. To be used with universal lateral support 9908009-9908019-9908022 to be ordered separately. Dimensions: 280 x 140 mm.</p> |
| <p>Code: 9908026</p> |  | <p>BACK BUTTOCKS WIDER SUPPORT Cushion complete with locking for universal support. It can be mounted either horizontally or vertically. To be used with universal lateral support 9908009-9908019-9908022 to be ordered separately. Dimensions: 280 x 140 mm.</p> |
| <p>Code: 9908005</p> |  | <p>SACRAL SUPPORT Cushion (size 200 x 80 mm), completed with antistatic cushion. Can be mounted either horizontally or vertically. To be used with universal lateral support 9908009/019/022 to be ordered separately.</p> |

| | | |
|----------------------------------|---|---|
| <p>Code: 9908004</p> |  | <p>CHEST SUPPORT Cushion (dimensions 170 x 200 mm), completed with locking for universal support. To be used with universal lateral support 9908009-019-022 to be ordered separately.</p> |
| <p>Code: 9908003</p> |  | <p>BUTTERFLY-SHAPED CHEST SUPPORT Cushion (size 270 x 100 mm), complete with locking for universal support. To be used with universal lateral support 9908009-9908019-9908022 to be ordered separately.</p> |
| <p>Code: 9908020</p> |  | <p>CYLINDRICAL LATERAL SUPPORT Cushion (height: 300 mm, diameter: 80 mm), complete with locking for universal support. To be used with support code 9908009-9908019-9908022 to be ordered separately.</p> |
| <p>Code: 9908021</p> |  | <p>FLAT SIZE BODY SUPPORT Body support complete with flat cushion (size: 200 x 80 mm), arm support and clamp.</p> |
| <p>Code: 9908021P</p> |  | <p>FLAT SIZE BODY SUPPORT FOR TABLE TOPS WITH VISCOELASTIC CUSHIONS Body support complete with flat cushion (size: 200 x 80 mm), arm support and clamp.</p> |
| <p>Code: 9908029</p> |  | <p>LATERAL SUPPORT FOR SHOULDER SURGERY Support complete with lateral body and cushion to be used for shoulder surgery in beach-chair position and as back support. Dimensions 509 mm height x 150 mm diameter, complete with clamp.</p> |







| | | |
|---------------------------------|---|--|
| <p>Code: 9921016</p> |  | <p>WEDGE-SHAPED PAD Special cushion for a comfortable patient positioning in lateral decubitus. Dimension: 900 x 480 x 200 mm.</p> |
| <p>Code: 9921018</p> |  | <p>SEMICIRCULAR CUSHION Special cushion for a comfortable semisitted/sitted and prone patient positioning. Dimensions 470 x 200 x 110 mm.</p> |
| <p>Code: 9921015</p> |  | <p>TUNNEL CUSHION Special cushion for patient leg protection in the position of lateral decubitus. Dimensions 650 x 480/380 x 220/150 mm.</p> |
| <p>Code: 9921019</p> |  | <p>CENTRAL VANTO CUSHION WITH COUNTERTRACTION DEVICE Central cushion for VANTO 8812-000 table top completed with support for counter traction bar.</p> |
| <p>Code: 9913002</p> |  | <p>SINGLE LEG SUPPORT Swivelling arch, complete with antistatic cushion. To position the patient's leg during surgical disinfection. To be used with clamp to be ordered separately.</p> |
| <p>Code: 9910002</p> |  | <p>INSTRUMENT TRAY Height adjustable, dimensions 470 x 370 mm. To be used with clamp to be ordered separately (advised code 9901023).</p> |
| <p>Code: 9907020</p> | | <p>ARCH-SHAPED DEVICE FOR COSTAL EDGE TRACTION for OPT 30/1, 40/1. With swivelling vertical bars, height adjustable for 335 mm thanks to clamps (included). Complete with 2 lateral extension bars (230 mm) and with 4 hooks.</p> |

| | | |
|-------------------------|---|---|
| |  | |
| Code: 9907059 |  | ARCH-SHAPED DEVICE FOR COSTAL EDGE TRACTION FOR CENTURY, VANTO AND ASSO With swivelling vertical bars, height adjustable for 335 mm thanks to clamps (included). Complete with 2 lateral extension bars (230 mm) and with 4 hooks. |
| Code: 9906022 |  | CURVED WIDTH EXTENSION (SINGLE) FOR OPT 30/1, 40/1, ASSO, CENTURY, VANTO, VITA It is used for ergonomic patient support. Complete with clamp and antistatic cushion. It can be matched with code 9960023 or it can be used singularly. Advised quantity: 2. Dimension: 200 x 200 mm. |
| Code: 9906023 |  | WIDTH EXTENSION FLAT SHAPE (SINGLE) FOR OPT 30/1, 40/1, CENTURY, ASSO, VANTO, VITA. It is used to increase the table top surface. Complete with clamp and antistatic cushion. Advised quantity: 2. |
| Code: 9920028 |  | CLEANING TROLLEY FOR VANTO COLUMN Trolley to lift column and clean thoroughly underneath the base. |
| Code: 9920001 |  | ACCESSORIES' TROLLEY In stainless steel. With three shelves and lateral rail supports for clamps. Dimensions: 935 mm length, 435 mm wide, 810 mm height. |
| Code: 9920003 |  | UNILATERAL STAINLESS STEEL ACCESSORIES TROLLEY Mobile trolley on antistatic castors of 90 mm diameter. With two 600 mm length, 25x10 mm size rails for accessories storage. Completed with one wire mesh basket, dimensions 285 x 600 x130h mm. |

| | | |
|---------------------------------|---|---|
| <p>Code: 9920006</p> |  | <p>BILATERAL STAINLESS STEEL ACCESSORIES TROLLEY Mobile trolley on antistatic castors of 90 mm diameter. With four (2 each side) 600 mm length, 25x10 mm size rails accessories storage. Completed with two (one each side) wire mesh baskets, dimensions 285 x 600 x130h mm each.</p> |
|---------------------------------|---|---|

| | | |
|---------------------------------|---|--|
| <p>Code: 9920051</p> |  | <p>COMPONENT STAND FOR VANTO For head, back and leg sections.</p> |
|---------------------------------|---|--|

ACCESSORIES FOR GYNAECOLOGY - UROLOGY

| | | |
|---------------------------------|---|--|
| <p>Code: 9902001</p> |  | <p>SINGLE LEG HOLDER WITH LOOPS With washable heel loops. Use with clamp to be ordered separately (advised code 9901023).</p> |
| <p>Code: 9902006</p> |  | <p>SINGLE THIGH HOLDER WITH CHAINS Completed with antistatic tubular rubber sleeves and padded chains. Use with clamp to be ordered separately (advised code 9901023).</p> |
| <p>Code: 9902002</p> |  | <p>SINGLE GOEPEL KNEE CRUTCH Knee crutch adjustable via ball-and-socket joint, included with cushion and fixing strap. Use with clamp to be ordered separately (advised code 9901023).</p> |
| <p>Code: 9902012</p> |  | <p>SINGLE PAEDIATRIC GOEPEL KNEE CRUTCH Knee crutch adjustable via ball-and-socket joint, included with cushion and fixing strap. Use with clamp to be ordered separately (advised code 9901023).</p> |
| <p>Code: 9902003</p> |  | <p>PAIR OF KNEE CRUTCHES Lengthwise, tiltable, and laterally adjustable on ball-and-socket joint. Included with cushion, fixing strap and clamps.</p> |
| <p>Code: 9902013</p> |  | <p>PAIR OF DIRECT PLACEMENT STIRRUP Adjustable by twisting a lever at the end of the accessory, which activates a gas spring. Complete with antistatic cushions and 2 clamps (code 990201300010). Weight for couple 10,5 kg. Patient maximum weight capacity: 160 kg.</p> |

| | | |
|---------------------------------|---|---|
| <p>Code: 9901015</p> |  | <p>SINGLE CLAMP FOR DIRECT PLACEMENT STIRRUP Reinforced clamp with high durability, for direct placement stirrup, advised quantity 2.</p> |
| <p>Code: 9911012</p> |  | <p>FRAME FOR INSTRUMENT TRAY OR T.U.R. DRAINAGE SET For either perineal instrument tray code 9911013 or T.U.R. drainage set code 9911202.</p> |
| <p>Code: 9911013</p> |  | <p>PERINEAL INSTRUMENT TRAY To be used with dedicated frame code 9911012 to be ordered separately.</p> |
| <p>Code: 9911202</p> |  | <p>UROLOGICAL PAN/T.U.R. DRAINAGE SET With drain and recovery strainer, and flexible tube to floor box. Use with frame code 9911012 to be ordered separately.</p> |
| <p>Code: 9911005</p> |  | <p>FLOOR MOBILE FRAME Liquid harvest mobile stainless steel bucket, complete with 4 castors and handle.</p> |
| <p>Code: 9924021</p> |  | <p>PATIENT HANDLE FOR GYNAECOLOGY (SINGLE) Advised quantity 2.</p> |





| | | |
|---------------------------------|---|--|
| <p>Code: 9907026</p> |  | <p>KNEE SUPPORT FOR PROCTOLOGY AND DISC SURGERY (PAIR) For proctology in genupectoral position. To attach onto the side rails of the single part leg section. Height and length adjustable for an optimal patient positioning.</p> |
| <p>Code: 9923076</p> |  | <p>CARBON SUPPORT FOR PERCUTANEOUS SURGERY WITH UNIQUE "FIX TORQUE" LOCKING SYSTEM Shaped carbon fibre support for percutaneous surgery. Complete with accessory side rails 25x10 mm to sustain the direct placement stirrups. Completely 360° radiolucent for a 405 mm line. It has a 50 mm high cushion. To be completed with direct placement stirrups. Dimension: 595x530 mm (590 mm side rails included) Weight: 13 kg</p> |

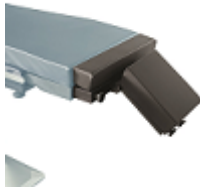

ACCESSORIES FOR VASCULAR



| | | |
|---------------------------------|---|---|
| <p>Code: 9906033</p> |  | <p>ARM SUPPORT UNDER THE CUSHION FOR VASCULAR TABLE TOP</p> |
| <p>Code: 9922002</p> |  | <p>X-RAY CASSETTE HOLDER Holding arm for positioning x-ray cassettes under radiotransparent table top. Mounted on side rails by clamp (included).</p> |
| <p>Code: 9929003</p> |  | <p>FRAME FOR X-RAY CASSETTES For the insertion of the x-ray cassettes under the table top. Dimensions: 300 x 460 mm.</p> |
| <p>Code: 9933015</p> |  | <p>PLATE WITH SIDE RAILS FOR CARBON FIBRE SECTIONS FOR OPT 30/1, 40/1, CENTURY, ASSO AND VANTO Radiolucent, with side rails holder. It is used on carbon fibre sections code 9933050 - 9933060 - 9930047.</p> |
| <p>Code: 9907076</p> |  | <p>(SINGLE) STANDING DEVICE FOR CARBON SECTIONS OF 1.200 MM Advised quantity: 2</p> |
| <p>Code: 9933023</p> | | <p>PLATE WITH SIDE RAIL FOR VANTO VASCULAR TABLE TOP AND XY TABLE TOP VANTO Radiolucent, with side rails. To be used with VANTO vascular table top and Vanto X/Y vascular table top. Dimension: 150x597 mm (639 mm side rails included) Weight: 3 kg</p> |



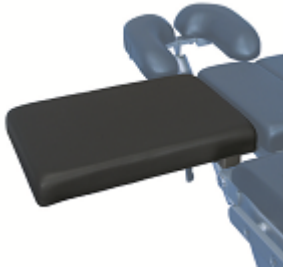
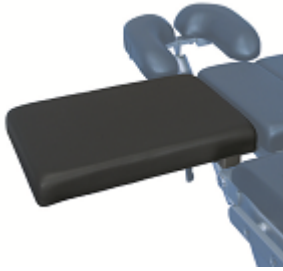
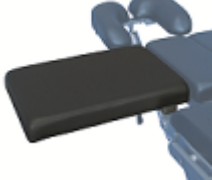
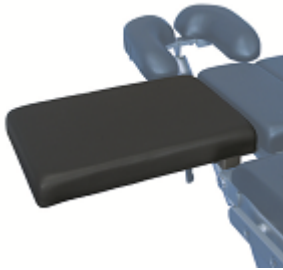

| | | |
|---------------------------------|---|--|
| |  | |
| <p>Code: 9905057</p> |  | <p>CARBON FIBRE HEAD SECTION FOR VASCULAR TABLE TOP FOR OPT 40/1 Complete with radiolucent and antistatic cushion. Dimension: 273x240 mm</p> |
| <p>Code: 9905068</p> |  | <p>HEADREST FOR VASCULAR AND XY VANTO TABLE TOP Removable, complete with soft, radiolucent and antistatic cushion, comfortable for the decubitus of the patient. For VANTO vascular table top - codes 8830000-8833000. Dimension: 300x550 mm Weight: 6 kg</p> |
| <p>Code: 9905071</p> |  | <p>RECLINABLE HEADREST FOR VANTO VASCULAR TABLE TOP AND XY TABLE TOP Removable and complete with integrated removable soft cushion, which is radiolucent, antistatic, viscoelastic and memory foam with a minimum thickness of 80 mm for a comfortable patient positioning even during long procedures. Dimension: 297x550 mm</p> |

ACCESSORIES FOR ORTHOPAEDICS AND TRAUMATOLOGY



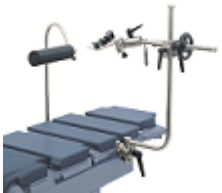

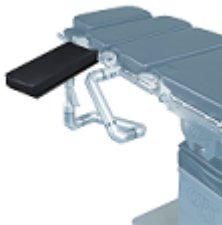
| | | |
|----------------------------------|---|--|
| <p>Code: 9907031</p> |  | <p>BACK PLATE FOR SHOULDER SURGERY FOR OPT 30/1 With two lateral adjustable and removable parts, for free positioning and access to the shoulder. Complete with adjustable headrest and its support.</p> |
| <p>Code: 9907065</p> |  | <p>BACK PLATE FOR SHOULDER SURGERY FOR OPT 40/1 With two lateral adjustable and removable parts, for free positioning and access to the shoulder. To be used with supporting bar (code 9924024) for horseshoe headrest (code 9905011) or helmet headrest (code 9905034), or helmet headrest (code 9905058), to be ordered separately.</p> |
| <p>Code: 9907061</p> |  | <p>REDUCED BACK PLATE FOR SHOULDER SURGERY FOR CENTURY, ASSO AND VANTO Reduced for table tops with integrated lower back section. With two lateral adjustable and removable parts, for free positioning and access to the shoulder. To be used with supporting bar (code 9924024) and horseshoe headrest (code 9905011) or helmet headrest (code 9905034), or helmet headrest (code 9905058), to be ordered separately.</p> |
| <p>Code: 9907061P</p> |  | <p>REDUCED BACK PLATE FOR SHOULDER SURGERY FOR CENTURY, VITA, ASSO AND VANTO WITH VISCOELASTIC CUSHIONS Reduced for table tops with integrated lower back section. With two lateral adjustable and removable parts, for free positioning and access to the shoulder. To be used with supporting bar (code 9924024) and horseshoe headrest (code 9905011) or helmet headrest (code 9905034), or helmet headrest (code 9905058), to be ordered separately. Complete with integrated soft viscoelastic, radiolucent, antistatic and easily removable cushions with shape memory (minimal thickness mm. 80) for a comfortable of the patient, even during long interventions.</p> |
| <p>Code: 9907071</p> |  | <p>BACK PLATE FOR SHOULDER SURGERY FOR CENTURY, ASSO AND VANTO With two lateral adjustable and removable parts, for a free access to the shoulder. To be used with supporting bar (code 9924024) for the horseshoe headrest (code 9905011), or helmet headrest (code 9905034) or helmet headrest (code 9905058) all to be ordered separately.</p> |



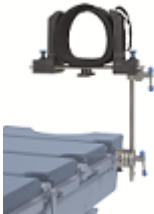

| | | |
|----------------------------------|---|---|
| <p>Code: 9907071P</p> |  | <p>BACK PLATE FOR SHOULDER SURGERY FOR CENTURY, ASSO AND VANTO with viscoelastic cushions With two lateral adjustable and removable parts, for a free access to the shoulder. To be used with supporting bar (code 9924024) for the horseshoe headrest (code 9905011), or helmet headrest (code 9905034) or helmet headrest (code 9905058) all to be ordered separately.</p> |
| <p>Code: 9914013</p> |  | <p>PADDED BODY STRAP Fixing system for the patient in beach-chair position to the side rails of the back plate for shoulder surgery. Washable, length 1.900 mm and width on the padded point 150 mm.</p> |
| <p>Code: 9908029</p> |  | <p>LATERAL SUPPORT FOR SHOULDER SURGERY Support complete with lateral body and cushion to be used for shoulder surgery in beach-chair position and as back support. Dimensions 509 mm height x 150 mm diameter, complete with clamp.</p> |
| <p>Code: 9924024</p> |  | <p>SUPPORTING BAR FOR HEADRESTS To be used with headrest (code 9905011) or helmet headrest (code 9905034/9905058) together with the back plate for shoulder surgery; or to be used with headrest (code 9905011 and 9905039) and the adapters to be ordered separately according to the table model.</p> |
| <p>Code: 9905034</p> |  | <p>HELMET-SHAPED HEAD REST To be used with supporting bar 9924024 and back plate for shoulder surgery.</p> |
| <p>Code: 9905058</p> |  | <p>MODULAR HELMET HEAD REST To be used with supporting bar 9924024 and back plate for shoulder surgery. The headrest is modular, with 2 easily removable lateral parts to facilitate anaesthesia of the patient.</p> |

| | | |
|----------------------------------|---|---|
| <p>Code: 9907072</p> |  | <p>LIGHT SHOULDER ARTHROSCOPY DEVICE FOR OPT 30/1, 40/1, ASSO, CENTURY AND VANTO With double traction system, tiltable, extensible, height adjustable and fully orientable on clamp. Completed with strings, belts and clamp.</p> |
| <p>Code: 9906027</p> |  | <p>PLATE FOR HUMERUS SURGERY FOR OPT 40/1 Radiolucent, to use with patient in prone position. It is complete with cushion. To be fitted onto back plate for shoulder surgery device code 9907065.</p> |
| <p>Code: 9906020</p> |  | <p>PLATE FOR HUMERUS SURGERY - SMALL HOOKS - FOR CENTURY, ASSO AND VANTO Radiolucent, to be used with patient in prone position. It is complete with cushion. To be fitted onto back plate for shoulder surgery code 9907061.</p> |
| <p>Code: 9906031</p> |  | <p>PLATE FOR HUMERUS SURGERY FOR BACK PLATE SHOULDER SURGERY- SMALL HOOKS FOR CENTURY, VANTO AND ASSO TABLES Radiolucent plate for humerus treatment with patient in prone position. It is complete with cushion. <i>To be fitted onto shoulder surgery device code 9907071.</i></p> |
| <p>Code: 9906031P</p> |  | <p>PLATE FOR HUMERUS SURGERY FOR CENTURY, VANTO AND ASSO with viscoelastic cushion Radiolucent plate for humerus treatment with patient in prone position. It is completed with cushion. With removable cushion, radiolucent and antistatic in memory foam viscoelastic material with a minimum width of 80 mm for a conformable patient decubitus on long lasting operations. To be fitted onto shoulder surgery device code 9907071P.</p> |
| <p>Code: 9909010</p> |  | <p>ADJUSTABLE HUMERUS SUPPORT Radiolucent with height range of 160 mm and longitudinal range 110 mm adjustment. Complete with cushion from 40 mm and clamp for side rail.</p> |

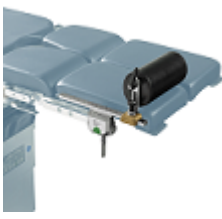
| | | |
|----------------------------------|---|---|
| <p>Code: 9909013</p> |  | <p>HEIGHT ADJUSTABLE PLATE FOR HUMERUS SURGERY Radiolucent, orientable on ball-and-socket joint, to use with patient in prone position. Complete with cushion and clamp for side rails. Height adjustment range of 150 mm.</p> |
| <p>Code: 9907038</p> |  | <p>HUMERUS AND FOREARM POSITIONING DEVICE With patient in supine position, made of a countertraction post, positioning system and hand traction. Complete with 2 clamps.</p> |
| <p>Code: 99070770</p> |  | <p>OPT ARM Patient positioning device for arthroscopic surgery. OPT Arm is used to safely move and hold the patient's arm during surgery. To be used with disposable kit (code 9907077S) to be ordered separately.</p> |
| <p>Code: 9907077S</p> |  | <p>DISPOSABLE KIT FOR OPT ARM Disposable kit for OPT Arm, complete with sterile drape made of velcro, a sterile cloth to cover the accessory and a sterile fixing tape. It contains 10 disposable pcs.</p> |
| <p>Code: 9907077D</p> |  | <p>ARM SUPPORT SURGERY TABLE FOR OPT ARM (Schuremed code 790-0056-0) Thanks to this plate it is possible to provide safe and easy patient positioning in lateral decubitus (park bench). To be used together with OPT Arm code 99070770.</p> |
| <p>Code: 9907077E</p> |  | <p>COUNTERTRACTION ARM FOR OPT ARM (Schuremed code 790-0057-0) To be used together with OPT Arm code 99070770.</p> |

| | | |
|---------------------------------|---|---|
| <p>Code: 9909002</p> |  | <p>NARROW HAND SURGERY TABLE Completely radiolucent, height adjustment range 55 mm, complete with antistatic cushion, traction device and clamp. Dimensions: 700 x 300 mm.</p> |
| <p>Code: 9909004</p> |  | <p>WIDE HAND SURGERY TABLE Completely radiolucent, height adjustment range 55 mm, complete with antistatic cushion, traction device and clamp. Dimensions: 700 x 500 mm.</p> |
| <p>Code: 9909014</p> |  | <p>CARBON FIBRE ARM AND HAND SURGERY TABLE WITHOUT STAND Extremely resistant and light, easy to use and completely radiolucent. Height adjustable for a correct alignment with the operating table. Complete with antistatic cushion and 2 clamps. Dimension: 760 x 380 mm.</p> |
| <p>Code: 9909015</p> |  | <p>ARM AND HAND PROCEDURE TABLE IN PHENOLIC RESIN WITHOUT STAND Extremely resistant and light, easy to use and completely radiolucent. Height adjustable for a correct alignment with the operating table. Complete with antistatic cushion and 2 clamps. Dimension: 760 x 380 mm.</p> |
| <p>Code: 9908027</p> |  | <p>HIP PROTHESIS POSITIONING DEVICE It is made of 2 height adjustable iliac crest tampon supports and 1 orientable and height adjustable sacral support. Complete with fast locking clamps to be fitted onto the side rails.</p> |
| <p>Code: 9925027</p> |  | <p>ADAPTER FOR CENTURY - VANTO - ASSO Adapter for devices for MIS hip surgery for CENTURY, VANTO and ASSO. To be attached to traction group code 9923052 or 9923060 (for Medacta, ImplanTec devices).</p> |

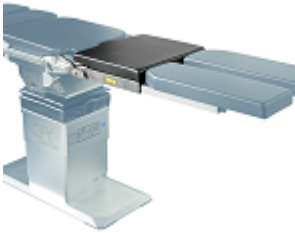
| | | |
|---------------------------------|---|---|
| <p>Code: 9923055</p> |  | <p>RADIOLUCENT PELVIS SURGERY DEVICE FOR CENTURY, ASSO, VITA AND VANTO To be used with tractioned limbs. Specialistic device completely radiolucent on its central part for pelvis surgery and fracture.</p> |
| <p>Code: 9907034</p> |  | <p>KNEE ARTHROSCOPY DEVICE Tilttable, height adjustable, with width regulation. Complete with padded belt and clamp.</p> |
| <p>Code: 9907075</p> |  | <p>FOLDABLE KNEE ARTHROSCOPY DEVICE Reclinable, spreadable, with tilttable adjustable lateral supports, complete with padding and clamp.</p> |
| <p>Code: 9907032</p> |  | <p>KNEE POSITIONING DEVICE WITH LATERAL ADJUSTABLE SUPPORTS WITH CLAMP Mounted on square section bar, with swivelling lateral adjustment supports, with clamp included.</p> |
| <p>Code: 9907003</p> |  | <p>MENISCUS POSITIONING DEVICE Mounted on square section bar, without knee lateral supports, with clamp included.</p> |
| <p>Code: 9909009</p> |  | <p>SLIDING ROLLER SUPPORT FOR KNEE PROTHESIS Height adjustable +/- 55 mm and length adjustable 340 mm. For a safe and precise patient positioning.</p> |

| | | |
|---------------------------------|---|---|
| <p>Code: 9907079</p> |  | <p>SLIDING POSITIONER FOR KNEE REPLACEMENT (LENGHT ADJST. 610 MM) Height and length adjustable and complete with ball joint that allows to flex, stretch, recline and rotate the patient's leg. Complete with clamp and a kit of disposable drapes 12 pieces. (code 9907079S).</p> |
| <p>Code: 9907080</p> |  | <p>SLIDING POSITIONER FOR KNEE PROTHESIS (LENGHT ADJST. 760 MM) Height and length adjustable and complete with ball joint that allows to flex, stretch, recline and rotate the patient's leg. Complete with clamp and a kit of disposable drapes 12 pieces. (code 9907079S).</p> |
| <p>Code: 9924027</p> |  | <p>TIBIA NAILING DEVICE With popliteus support, complete with cushions and height adjustable. To be fitted onto lower limbs traction device code 9923042-9923046-9923052-9923060 with the possibility of adjusting the leg inclination.</p> |
| <p>Code: 9923069</p> |  | <p>CARBON FIBRE HIP PROTHESIS DEVICE IN FOR VANTO, ASSO AND CENTURY Made of carbon fibre and completed with pad. To be used with patient in supine position for a complete radiotransparency and with removable and interchangeable leg supports (code 9923067).</p> |
| <p>Code: 9923067</p> |  | <p>PAIR OF TRACTION LEG SUPPORTS FOR CENTURY, VANTO AND ASSO Leg section for traction support with ball coupling, not tiltable. Included in lower limbs traction device code 9923052 and necessary to use the hip prosthesis device code 9923069.</p> |

| | | |
|---------------------------------|---|---|
| <p>Code: 9923020</p> |  | <p>RIGID TRACTION DEVICE WITH STIRRUP To be used with traction arm and screw tension device. Can be rotated and tilted.</p> |
| <p>Code: 9902014</p> |  | <p>POPLITEUS HOLDER ARCH (SINGLE) For lower limbs traction device, complete with clamp. Advised quantity: 2.</p> |
| <p>Code: 9902017</p> |  | <p>RADIOLUCENT POPLITEUS HOLDER PLATE (SINGLE) For lower limbs traction device, radiolucent and complete with clamp. Advised quantity: 2.</p> |
| <p>Code: 9924001</p> |  | <p>PELVIC HOLDER SET WITH SPATULA AND EXTENTION The set is supplied with orthopedic-traumatology table top. The set is equipped with code 9924010- spatula for adults code 9924510 - spatula for children code9907009 - countertraction rod code 9924201 - long extension support for pelvic holder set code 9907011- short extension support for pelvic holder set.</p> |
| <p>Code: 9901016</p> |  | <p>CLAMP FOR TRACTION DEVICE Square clamp for arm height traction.</p> |
| <p>Code: 9912001</p> |  | <p>ANKLE LEATHER CUFFS (PAIR) FOR ADULTS To be used with lower limbs traction device.</p> |

| | | |
|---------------------------------|---|--|
| <p>Code: 9912002</p> |  | <p>ANKLE LEATHER CUFFS (PAIR) PAEDIATRIC To be used with lower limbs traction device.</p> |
| <p>Code: 9912003</p> |  | <p>ANKLE LEATHER CUFFS - (1 FOR ADULT AND 1 FOR CHILDREN) To be used with lower limbs traction device.</p> |
| <p>Code: 9924704</p> |  | <p>CYLINDRICAL CUSHION FOR HIP ARTHROSCOPY For hip arthroscopy with diameter 200 mm.</p> |
| <p>Code: 9923078</p> |  | <p>COUNTERTRACTION DEVICE FOR OBESES Support for countertraction bar for bariatric surgery to be fitted on lower limbs traction device.</p> |
| <p>Code: 9918003</p> |  | <p>ADULT TRACTION BOOT - SIZE M 41/45 To be fixed to a metal plate on a ball-and-socket joint. To be used with lower limbs traction device. Can be used on both right and left foot.</p> |
| <p>Code: 9918004</p> |  | <p>PAEDIATRIC TRACTION BOOT SIZE S 35/40 To be fixed to a metal plate on a ball-and-socket joint. To be used with lower limbs traction device. Can be used on both right and left foot.</p> |

| | | |
|---------------------------------|---|---|
| <p>Code: 9919001</p> |  | <p>ELONGATION BAR LENGTH 480 MM Complete with clamp</p> |
| <p>Code: 9919003</p> |  | <p>ELONGATION BAR - LENGTH 300 MM Complete with clamp.</p> |
| <p>Code: 9923051</p> |  | <p>TRUNCH AND THORAX PLASTER DEVICE FOR VANTO, VITA, ASSO AND CENTURY Complete with vertical support, height adjustable, with fork scapulars support and headrest for adults and children.</p> |
| <p>Code: 9923061</p> |  | <p>TRUNCH AND THORAX PLASTER DEVICE FOR OPT 30/1 AND 40/1 Complete with vertical support, height adjustable, with fork scapulars support and headrest for adults and children.</p> |
| <p>Code: 9923079</p> |  | <p>PELVIC - PODALIC ACCESSORY FOR OPT 30/1 AND 40/1 In radiolucent material. Complete with countertraction post and spatula supports for adults and children. Possibility of being attached to the operating table and/or traction device group. The code 9923079 applies only to a traction device.</p> |
| <p>Code: 9923071</p> |  | <p>PELVIC - PODALIC ACCESSORY FOR CENTURY, VANTO, VITA AND ASSO In radiolucent material. Complete with countertraction post and spatula supports for adults and children. Possibility of being attached to the operating table and/or traction device group. The code 9923079 applies only to a traction device.</p> |

| | | |
|---------------------------------|---|---|
| <p>Code: 9923057</p> |  | <p>PELVIS PLASTER DEVICE FOR OPT VANTO, ASSO, VITA AND CENTURY Complete with countertraction post and spatula supports for adults and children. To be attached to the lower limbs traction device.</p> |
| <p>Code: 9923062</p> |  | <p>STIRRUP TRACTION DEVICE For models Martin, Aescolap, etc.</p> |

LOWER LIMBS TRACTION DEVICE

Traction devices

| | | | |
|---------------------------------|---|--|-----------------------------------|
| <p>Code: 9923046</p> |  | <p>LOWER LIMBS TRACTION DEVICE FOR OPT 30/1 AND OPT 40/1. Complete with: 1 fixed pelvis support; 1 traction arm incl. screw tension device (to be used indifferently left or right); 1 standing leg/bar; 1 countertraction bar with cylindrical cushion (code 9924025); 1 elongation bar (code 9919001); 1 adult traction boot - size M (code 9918003); 1 single Goepel knee crutch (code 9902002); 1 radial setting clamp (code 9901023) To be used only with standing leg installed.</p> | <p>Price 2017</p> <p>5.971,00</p> |
|---------------------------------|---|--|-----------------------------------|

Optional to complete the traction device

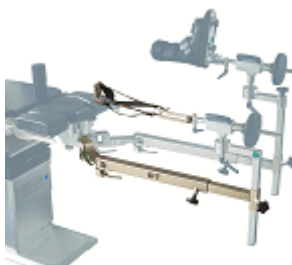
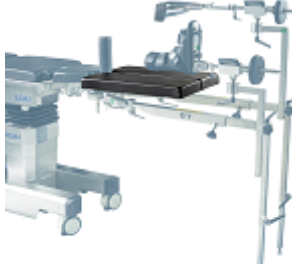
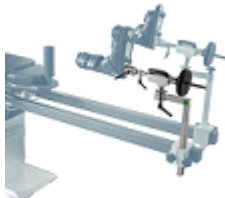
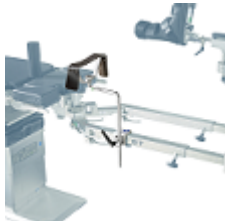
| | | |
|---------------------------------|---|---|
| <p>Code: 9923047</p> |  | <p>SINGLE TRACTION ARM FOR OPT 30/1 AND 40/1, complete with: 1 stirrup; 2 ankle leather cuffs (1 for adults and 1 for children); 1 plate for positioning the safe leg; 1 standing leg/bar Without screw tension device to be ordered separately.</p> |
| <p>Code: 9923064</p> |  | <p>PAIR OF TRACTION LEG SUPPORTS FOR OPT 30/1-40/1 Legs section for traction support with sphere graft. Not tiltable. Advised for lower limbs traction device code 9923046.</p> |
| <p>Code: 9923049</p> |  | <p>SCREW TENSION DEVICE For the second traction arm code 9923047, 9923053, 9923066.</p> |
| <p>Code: 9902014</p> |  | <p>POPLITEUS HOLDER ARCH (SINGLE) For lower limbs traction device, complete with clamp. Advised quantity: 2.</p> |

| | | | |
|---------------------------------|---|--|---------------------------------|
| <p>Code: 9924026</p> |  | <p>L-SHAPED COUNTER TRACTION AND PELVIS SUPPORT POST To be used on lower limbs traction device with patient in lateral decubitus.</p> | <p>Price 2017</p> <p>335,00</p> |
|---------------------------------|---|--|---------------------------------|

Traction device for VANTO - ASSO - CENTURY





| | | | |
|---------------------------------|---|---|-----------------------------------|
| <p>Code: 9923052</p> |  | <p>LOWER LIMBS TRACTION DEVICE FOR CENTURY, VANTO AND ASSO, complete with: n. 1 fixed pelvis support; n. 1 pair of tiltable and removable buttocks support; n. 1 traction arm incl. screw tension device (to be used indifferently left or right); n. 1 pair removable leg supports; n.1 countertraction bar with cylindrical cushion (code 9924025); n. 1 adult traction boot - size M (code 9918003); n. 1 single Goepel knee crutch (code 9902002); n. 1 clamp for Goepel knee crutch (code 9901023). On Vanto table top code 8815000 must be used the standing device leg/bar code 9923074</p> | <p>Price 2017</p> <p>9.279,00</p> |
|---------------------------------|---|---|-----------------------------------|

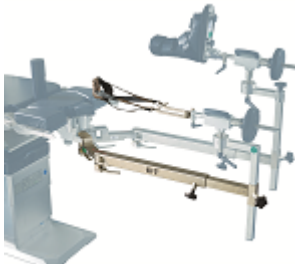
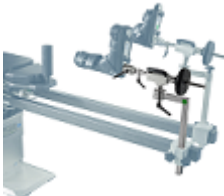

Traction device with viscoelastic cushions for VANTO - ASSO - CENTURY - VITA

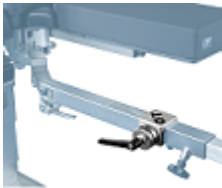
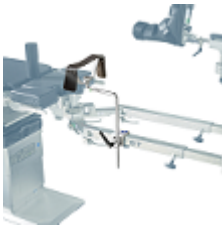
| | | | |
|----------------------------------|---|--|-----------------------------------|
| <p>Code: 9923052P</p> |  | <p>LOWER LIMBS TRACTION DEVICE FOR CENTURY, VANTO, VITA AND ASSO WITH VISCOELASTIC CUSHIONS, complete with: n. 1 fixed pelvis support; n. 1 pair of tiltable and removable buttocks support; n. 1 traction arm incl. screw tension device (to be used indifferently left or right); n. 1 pair removable leg supports; n.1 countertraction bar with cylindrical cushion (code 9924025); n. 1 adult traction boot - size M (code 9918003); n. 1 single Goepel knee crutch (code 9902002); n. 1 clamp for Goepel knee crutch (code 9901023). Cushions are viscoelastic and memory foam with minimum thickness 80 mm.</p> | <p>Price 2017</p> <p>9.279,00</p> |
|----------------------------------|---|--|-----------------------------------|



Optional to complete the traction device



| | | | |
|---------------------------------|---|--|-----------------------------------|
| <p>Code: 9923053</p> |  | <p>SINGLE TRACTION ARM FOR ASSO, VANTO, VITA AND CENTURY, complete with: 1 stirrup, 2 ankle leather cuffs (1 for adult and 1 for children), 1 plate for positioning the safe leg Complete with:</p> <ul style="list-style-type: none"> • 1 stirrup • 2 ankle leather cuffs (1 for adults and 1 for children) • 1 plate for positioning the safe leg <p>Without screw tension device to be ordered separately.</p> | <p>Price 2017</p> <p>2.631,00</p> |
| <p>Code: 9923049</p> |  | <p>SCREW TENSION DEVICE For the second traction arm code 9923047, 9923053, 9923066.</p> | <p>Price 2017</p> <p>1.186,00</p> |

| | | |
|---------------------------------|---|--|
| <p>Code: 9923077</p> |  | <p>SCREW TENSION DEVICE WITH HORIZONTAL ADJUSTMENT For the second traction arm code 9923047, 9923053 and 9923066.</p> |
| <p>Code: 9901016</p> |  | <p>CLAMP FOR TRACTION DEVICE Square clamp for arm height traction.</p> |
| <p>Code: 9902014</p> |  | <p>POPLITEUS HOLDER ARCH (SINGLE) For lower limbs traction device, complete with clamp. Advised quantity: 2.</p> |
| <p>Code: 9918003</p> |  | <p>ADULT TRACTION BOOT - SIZE M 41/45 To be fixed to a metal plate on a ball-and-socket joint. To be used with lower limbs traction device. Can be used on both right and left foot.</p> |
| <p>Code: 9918004</p> |  | <p>PAEDIATRIC TRACTION BOOT SIZE S 35/40 To be fixed to a metal plate on a ball-and-socket joint. To be used with lower limbs traction device. Can be used on both right and left foot.</p> |
| <p>Code: 9924026</p> |  | <p>L-SHAPED COUNTER TRACTION AND PELVIS SUPPORT POST To be used on lower limbs traction device with patient in lateral decubitus.</p> |

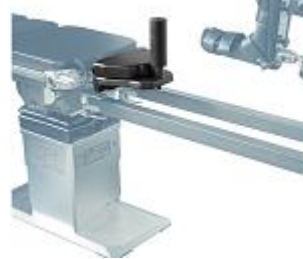
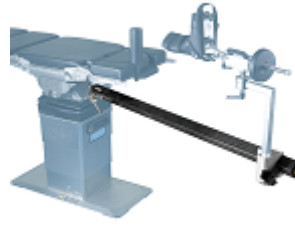

| | | |
|---------------------------------|---|--|
| <p>Code: 9923045</p> |  | <p>REMOVABLE TRACTION STANDING DEVICE LEG/BAR FOR VANTO, ASSO AND CENTURY For the lower limbs traction device code 9923052 and 9923052P.</p> |
| <p>Code: 9923074</p> |  | <p>REMOVABLE TRACTION STANDING DEVICE LEG/BAR FOR VANTO ORTHOPAEDIC TABLE TOP (code 8815000) For the lower limbs traction device code 9923052 and 9923052P.</p> |



Radiolucent traction device for VANTO - ASSO - CENTURY

| | | |
|---------------------------------|---|--|
| <p>Code: 9923065</p> |  | <p>RADIOLUCENT CARBON FIBRE LOWER LIMBS TRACTION DEVICE, FOR CENTURY, VANTO, VITA AND ASSO, complete with: -n.1 radiolucent fixed pelvis support; -n.1 countertraction bar; -n.1 pair of tiltable and removable buttock support To be completed necessarily with:</p> <ul style="list-style-type: none"> • 2 carbon fibre traction arms • 2 screw tension devices • 2 adult traction boots <p><i>Note: with the tractions on the operating table Vanto code 8815000 it is mandatory to use standing device leg/bar code 9923074.</i></p> |
| <p>Code: 9923066</p> |  | <p>SINGLE CARBON FIBRE ROTATED TRACTION BAR (INDIFFERENTLY RIGHT OR LEFT) FOR OPT CENTURY, VITA, VANTO AND ASSO and complete with: n.1 clamp for positioning the screw tension device and n. 1 stirrup It allows a better exposure to x-rays thanks to a configuration that avoids stacking the carbon fibre layers.</p> <p>Without screw tension device to be ordered separately.</p> |
| <p>Code: 9918003</p> |  | <p>ADULT TRACTION BOOT - SIZE M 41/45 To be fixed to a metal plate on a ball-and-socket joint. To be used with lower limbs traction device. Can be used on both right and left foot.</p> |





| | | |
|---------------------------------|--|--|
| <p>Code: 9918004</p> |  | <p>PAEDIATRIC TRACTION BOOT SIZE S 35/40 To be fixed to a metal plate on a ball-and-socket joint. To be used with lower limbs traction device. Can be used on both right and left foot.</p> |
| <p>Code: 9923049</p> |  | <p>SCREW TENSION DEVICE For the second traction arm code 9923047, 9923053, 9923066.</p> |
| <p>Code: 9923077</p> |  | <p>SCREW TENSION DEVICE WITH HORIZONTAL ADJUSTMENT For the second traction arm code 9923047, 9923053 and 9923066.</p> |

Trolley for traction device





| | | |
|---------------------------------|---|--|
| <p>Code: 9923048</p> |  | <p>TROLLEY FOR MOUNTED TRACTION DEVICE FOR OPT 30/1-40/1 Completed with wire mesh basket, dimension 600 mm x 600 mm x 300 h mm. To be used only with two traction arms.</p> |
| <p>Code: 9920070</p> |  | <p>TROLLEY FOR MOUNTED LOWER LIMBS TRACTION DEVICE FOR CENTURY - VANTO - ASSO For standard tractions. Complete with wire mesh (dimensions: 600 x 600 mm x h 300 mm). To be ordered according to the kind of table (Asso/Vanto/Century), the column (fixed/mobile/plus) and operating table top.</p> |
| <p>Code: 9920071</p> |  | <p>TROLLEY FOR MOUNTED LOWER LIMBS TRACTION DEVICE FOR CENTURY - VANTO - ASSO WITH CARBON FIBRE TRACTION For carbon tractions. Complete of wire mesh basket (dimension: 600 x 600 mm x h 300 mm). To be ordered according to the kind of table top (Asso/Vanto/Century), the column (fixed/mobile/plus) and to the table top.</p> |





| | | |
|----------------------------------|--|---|
| <p>Code: 9920050S</p> |  | <p>PREPARATION FOR TROLLEYS FOR LOWER LIMBS TRACTION DEVICE TO BE USED WITH A SINGLE TRACTION ARM Preparation device for trolleys for lower limb traction device that allows to move safely the tractions 9923052/9923052P with a single traction arm.</p> |
| <p>Code: 9920026</p> |  | <p>CUBE TROLLEY FOR DISMOUNTED TRACTION DEVICE For the rapid and tidy storage of the entire traction system.</p> |
| <p>Code: 9920055</p> |  | <p>CUBE TROLLEY FOR DISMOUNTED CARBON FIBRE TRACTION DEVICE FOR VANTO-ASSO-CENTURY For the rapid and tidy storage of the entire dismounted traction system.</p> |

ACCESSORIES FOR ENT-NEUROSURGERY



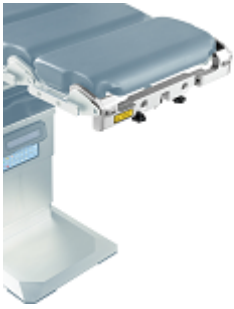
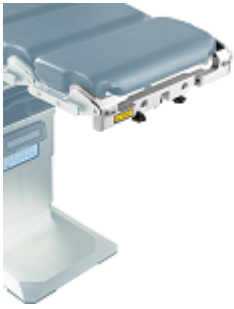

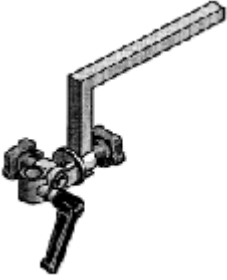
| | | |
|---------------------------------|---|--|
| <p>Code: 9925010</p> |  | <p>SQUARE SECTION ADAPTER FOR HEAD REST OPT 30/1 Connecting adapter for headrest or for headrest supporting bar (code 9924024), to be used in place of standard headrest of the table.</p> |
| <p>Code: 9925024</p> |  | <p>SQUARE SECTION ADAPTER FOR HEADREST FOR OPT 40/1 Connecting adapter for headrest or for headrest supporting bar (code 9924024), to be used in place of standard headrest of the table.</p> |
| <p>Code: 9925052</p> |  | <p>ADAPTER FOR HEAD REST FOR CENTURY, VITA, VANTO AND ASSO Connecting adapter for headrest or for headrest supporting bar (code 9924024), to be used in place of standard headrest of the table.</p> |
| <p>Code: 9924024</p> |  | <p>SUPPORTING BAR FOR HEADRESTS To be used with headrest (code 9905011) or helmet headrest (code 9905034/9905058) together with the back plate for shoulder surgery; or to be used with headrest (code 9905011 and 9905039) and the adapters to be ordered separately according to the table model.</p> |
| <p>Code: 9905034</p> |  | <p>HELMET-SHAPED HEAD REST To be used with supporting bar 9924024 and back plate for shoulder surgery.</p> |

| | | |
|---------------------------------|---|--|
| <p>Code: 9905011</p> |  | <p>HORSE-SHOE SHAPED HEAD REST Height and width adjustable, swivelling on ball and socket joint, complete with antistatic cushion. To be used with supporting bar (code 9924024) and adapter (according to the table model), both to be ordered separately.</p> |
| <p>Code: 9905035</p> |  | <p>HORSE-SHOE SHAPED FACIAL SUPPORT Width adjustable, for patient in prone position. Complete with cushions, supporting bar and clamp. To be used with cushion code 9921002 (to be ordered separately).</p> |
| <p>Code: 9905003</p> |  | <p>HEADREST ON BALL JOINT Height adjustable, complete with antistatic cushions. To be used with connecting adapter (to be ordered in according to the table top) to be ordered separately.</p> |
| <p>Code: 9905002</p> |  | <p>HEADREST - INCLINATION ADJUSTABLE BY A SCREW Height adjustable, complete with antistatic cushions. To be used with connecting adapter (to be ordered in according to the table top) to be ordered separately.</p> |
| <p>Code: 9905001</p> |  | <p>HEADREST - HEIGHT ADJUSTABLE BY ROTATING KNOB Swivelling on ball and socket joint, complete with antistatic cushions. To be used with connecting adapter (to be ordered in according to the table top) to be ordered separately.</p> |
| <p>Code: 9905021</p> |  | <p>CIRCULAR HEADREST WITH ELBOW SUPPORT FOR OPT 30/1 Tiltable, height adjustable, with special elbow rest for surgeon with possibility of vertical and longitudinal adjustments. Complete with cushion. Adapter included.</p> |

| | | |
|---------------------------------|---|--|
| <p>Code: 9905048</p> |  | <p>CIRCULAR HEAD REST WITH ADAPTER FOR OPT 40/1 Tilttable, height adjustable, with special elbow rest for surgeon with possibility of vertical and longitudinal adjustments. Complete with cushion. Adapter included.</p> |
| <p>Code: 9907012</p> |  | <p>CROSS-BAR ATTACHMENT FOR SKULL CLAMP FOR OPT 30/1 AND 40/1 For head positioning accessories and neurosurgery accessories, with patient in a seated position. Complete with clamps.</p> |
| <p>Code: 9907058</p> |  | <p>CROSS-BAR ATTACHMENT FOR SKULL CLAMP FOR CENTURY, VITA, ASSO AND VANTO TABLES For head positioning accessories and neurosurgery accessories, with patient in a seated position. Complete with clamps.</p> |
| <p>Code: 9925016</p> |  | <p>ADAPTER FOR ALLOY HEADRESTS FOR OPT 30/1 To be used instead of the standard head section, it is used to fix the headrest or the supporting bar code 9905038.</p> |
| <p>Code: 9925025</p> |  | <p>ADAPTER FOR ALLOY HEADRESTS FOR OPT 40/1 To be used instead of standard head section, it is used to fix the headrest or the supporting bar code 9905038.</p> |

| | | |
|---------------------------------|---|---|
| <p>Code: 9925053</p> |  | <p>ADAPTER FOR ALLOY HEADRESTS FOR CENTURY, VITA, VANTO AND ASSO To be used instead of the standard head section, it is used to fix the headrest or the supporting bar code 9905038.</p> |
| <p>Code: 9925054</p> |  | <p>RADIOLUCENT ADAPTER FOR ALLOY HEADRESTS FOR CENTURY, VITA, ASSO AND VANTO To be used instead of the standard head section, it is used to fix the headrest or the supporting bar code 9905038.</p> |
| <p>Code: 9905038</p> |  | <p>SUPPORTING BAR - DOUBLE LEVER Support for square-shaped headrest to be used with trapezoidal back section plate (code 9907068 or 9907063), or with square-shaped insert adaptor for headrest 9905011 and 9905039.</p> |
| <p>Code: 9908025</p> |  | <p>JOINTED HEADREST SUPPORTING BAR Support for square-shaped headrest to be used with trapezoidal back section plate (code 9907068 or 9907063), or with square-shaped insert adaptor for headrest 9905011 and 9905039.</p> |
| <p>Code: 9905039</p> |  | <p>SQUARE-SHAPED HEADREST To be used with supporting bar 9905038 and head section adapter (to be ordered according to the table) or with supporting bar 9924024 and related head section adapter (to be ordered according to the table).</p> |
| <p>Code: 9906009</p> |  | <p>PAIR OF ELBOW SUPPORTS Height adjustable, swivelling on ball and socket joint. Complete with antistatic cushions and clamps.</p> |

| | | |
|----------------------------------|---|--|
| <p>Code: 9921009</p> |  | <p>SQUARE-SHAPED HEAD REST FOR ADULTS Square, ergonomic shape, radiolucent and antistatic material. Dimensions 260 x 260 x 80 mm.</p> |
| <p>Code: 9921010</p> |  | <p>SQUARE-SHAPED HEADREST PAEDIATRIC Square, ergonomic shape, radiolucent and antistatic material. Dimensions: 240 x 240 x 80 mm.</p> |
| <p>Code: 9921013</p> |  | <p>CIRCULAR HEADREST FOR ADULTS Radiolucent and antistatic. Dimensions: outside diameter 210 mm; inside diameter 120 mm.</p> |
| <p>Code: 9921014</p> |  | <p>CIRCULAR HEADREST PAEDIATRIC Radiolucent and antistatic material. Dimensions: outside diameter 180 mm; inside diameter 90 mm.</p> |
| <p>Code: C3103400</p> |  | <p>RADIOLUCENT SPINAL FRAME Radiolucent spine surgery frame, to position the patient in prone position, type "Wilson". Entirely radiolucent (360°).</p> |
| <p>Code: 9907057</p> |  | <p>POSITIONING DEVICE FOR INTERVERTEBRAL DISC PROCEDURE IN DOUBLE MOVEMENT FOR CENTURY, VANTO AND ASSO To position the patient in genupectoral position. Complete with buttocks support, lateral patient body supports and height adjustable knee support by crank.</p> |

| | | |
|---------------------------------|---|--|
| <p>Code: 9923063</p> |  | <p>CERVICAL RACHIS TRACTION DEVICE To be used with head rest adapter (according to the table model), supporting bar 9924024 and head rest 9905011, to be ordered separately.</p> |
| <p>Code: 9920022</p> |  | <p>TROLLEY FOR POSITIONING DEVICE FOR INTERVERTEBRAL DISC PROCEDURE FOR VANTO CODE 9907057 Trolley for transport and easy mounting/dismounting of positioning device. Completed with 2 wire mesh baskets of the following dimensions: 600 x 300 x 130h mm. For VANTO with table top code 8812000.</p> |
| <p>Code: 9920031</p> |  | <p>TROLLEY FOR POSITIONING DEVICE FOR INTERVARTEBRAL DISC PROCEDURE FOR ASSO Code 9907057 Trolley for transport and easy mounting/dismounting of positioning device. Completed with 2 wire mesh baskets of the following dimensions: 600 x 300 x 130h mm.</p> |
| <p>Code: 9920032</p> |  | <p>TROLLEY FOR POSITIONING DEVICE FOR INTERVERTEBRAL DISC PROCEDURE Code 9907057 FOR VANTO LIGHT Trolley for transport and easy mounting/dismounting of positioning device. Completed with 2 wire mesh baskets of the following dimensions: 600 x 300 x 130h mm. For VANTO with table top code 8811000.</p> |
| <p>Code: 9920035</p> |  | <p>TROLLEY FOR POSITIONING DEVICE FOR INTERVERTEBRAL DISC PROCEDURE CODE 9907057 FOR CENTURY It is used to transport, attach and detach the positioning device. Complete of 2 wire mesh baskets of the following dimensions: 600 x 300 mm x 130h mm.</p> |

| | | |
|---------------------------------|---|---|
| <p>Code: 9907026</p> |  | <p>KNEE SUPPORT FOR PROCTOLOGY AND DISC SURGERY (PAIR) For proctology in genupectoral position. To attach onto the side rails of the single part leg section. Height and length adjustable for an optimal patient positioning.</p> |
| <p>Code: 9907016</p> |  | <p>SPINAL CORD POSITIONING DEVICE FOR OPT 30/1 AND 40/1 Special device for spinal cord surgery, totally radiolucent, with arch shape (100°) and abdominal cut out (dimensions 150 x 500 mm). Complete with ergonomic cushions and edges for iliac crests; rotating, swivelling, and height adjustable knee supports.</p> |
| <p>Code: 9921002</p> |  | <p>CUSHION FOR DISC SURGERY For intervertebral disc surgical operation, with abdominal cut-out. Dimensions: 815 x 450 x 95 mm. (Dimensions of internal bore: 345x195 mm)</p> |
| <p>Code: 9930033</p> |  | <p>CUSHION FOR SPINE SURGERY PAEDIATRIC For intervertebral disc surgical operation, with abdominal cut-out. Dimensions: 615 x 350 x 85 mm.</p> |

MAYFIELD HEADREST

| | | |
|----------------------------------|---|---|
| <p>Code: C3101611</p> |  | <p>SKULL CLAMP Provides 3-point rigid cranial fixation.</p> <ul style="list-style-type: none"> • Flexibility and safety in positioning of skull pins around critical areas of the skull • Quick-release lock |
| <p>Code: C3101613</p> |  | <p>ADULT HORSESHOE HEADREST (A-1012) Horseshoe shaped headrest provides cranial support in the prone or supine position for adults and older children.</p> <ul style="list-style-type: none"> • Vertical and lateral adjustments allow flexibility in patient positioning • Adjustable pad base accommodates various head sizes • Fluid resistant gel pads provide comfort and reduce the incidence of pressure necrosis • Pulley Rod attachment for skeletal traction |

| | | |
|----------------------------------|---|--|
| <p>Code: C3101614</p> |  | <p>ADULT REUSABLE SKULL PINS (A-1047) Single - Minimum required qty 3. Reusable.</p> |
| <p>Code: C3101615</p> |  | <p>CHILD REUSABLE SKULL PINS (A-1048) Single - Minimum required qty 3. Reusable.</p> |
| <p>Code: C3102321</p> |  | <p>ULTRA BASE UNIT (A-2101) Support that facilitates attaching the skull clamp or the skull clamp to the operating table.</p> |
| <p>Code: C3102323</p> |  | <p>ADAPTOR (A-1018) Attaches to base unit to provide flexibility in positioning via 360°rotation. Adapts skull clamps to base units.</p> |
| <p>Code: C3102610</p> |  | <p>PAEDIATRIC HORSESHOE REST (A-1051) Horseshoe shaped headrest provides cranial support in the prone or supine position for infants and young children.</p> <ul style="list-style-type: none"> • Vertical and lateral adjustments allow flexibility in patient positioning • Adjustable pad base accommodates various head sizes • Fluid resistant gel pads provide comfort and reduce the incidence of pressure necrosis • Easily cleaned |
| <p>Code: C3103728</p> |  | <p>CARBON FIBRE RADIOLUCENT HEADREST SYSTEM, COMPLETE WITH: -radiolucent skull clamp; - radiolucent ultra base unit; -disposable adult skull pins - 3 pcs</p> <ul style="list-style-type: none"> • Skull clamp radiotransparent (A-2114) • Ultra base unit radiotransparent (A-2079) • Adult skull pins mono use - qty 3 (A-2020) |





| | | |
|--|--|--|
| | | |
|--|--|--|





DORO HEADREST





| | | |
|----------------------------------|---|--|
| <p>Code: C3103747</p> |  | <p>ALLOY SKULL CLAMP (3003-00) Provides 3 point rigid cranial fixation by giving flexibility and safety in the positioning of the pins around the critical areas of the skull. With quick release lock.</p> |
| <p>Code: C3103749</p> |  | <p>ADULT REUSABLE SKULL PINS 3 pcs kit (3005-00) Reusable.</p> |
| <p>Code: C3103750</p> |  | <p>CHILD REUSABLE SKULL PIN 3 pieces kit (3004-00) Reusable</p> |
| <p>Code: C3103785</p> |  | <p>ADULT HORSESHOE HEADREST (3009-00) Adult horseshoe rest for skull support in prone or supine position. With vertical and lateral adjustments that allow flexibility in patient positioning. Adjustable pad base accommodates various head sizes and gel pads for more comfort. With pulley rod attachment for skeletal traction.</p> |
| <p>Code: C3103746</p> |  | <p>ULTRA BASE UNIT (3001-00) Support that facilitates attaching the skull clamp or the skull clamp to the operating table.</p> |
| <p>Code: C3103748</p> |  | <p>SWIVEL ADAPTOR (3002-00) Attaches to base unit to provide flexibility in positioning via 360°rotation. Adapts skull clamps to base units.</p> |

| | | |
|----------------------------------|---|--|
| <p>Code: C3103821</p> |  | <p>PAEDIATRIC HORSESHOE REST (3008-02) Horseshoe shaped headrest provides cranial support in the prone or supine position for infants and young children. Vertical and lateral adjustments allow flexibility in patient positioning. Adjustable pad base accommodates various head sizes. Complete with gel pads that provide comfort.</p> |
| <p>Code: C3103751</p> |  | <p>CARBON FIBRE RADIOLUCENT HEADREST SYSTEM (3030-00) With the disposable adult skull pins (36 pcs.) - code C3103807; or with the disposable children skull pins (36 pcs.) - code C3103808. Complete with:</p> <ul style="list-style-type: none"> • radiolucent skull clamp • radiolucent ultra base unit • disposable adult skull pins - quantity 3 |

GEL PADS







| | | |
|----------------------------------|---|---|
| <p>Code: C3103178</p> |  | <p>GEL CLOSED HEAD RING Diameter 9x4x2 cm (DM AP001)</p> |
| <p>Code: C3103139</p> |  | <p>GEL CLOSED HEAD RING Diameter 14 x 6 x 3,5 cm (DM AP002)</p> |
| <p>Code: C3103127</p> |  | <p>GEL CLOSED HEAD RING Diameter: 20 x 7,5 x 4,5 cm (DM AP003)</p> |
| <p>Code: C3103180</p> |  | <p>GEL OPEN HEAD RING Diameter: 9 x 4 x 2 cm (DM AP011)</p> |
| <p>Code: C3103159</p> |  | <p>GEL OPEN HEAD RING Diameter: 14 x 6 x 3,5 cm (DM AP012)</p> |

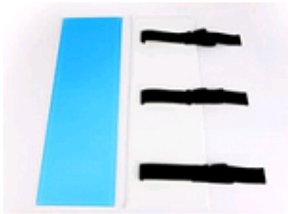
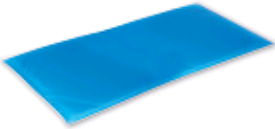
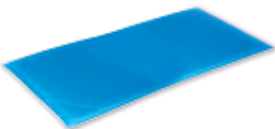
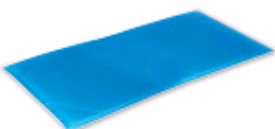

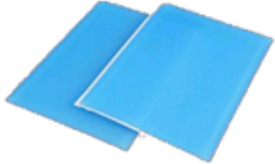

| | | |
|----------------------------------|---|---|
| <p>Code: C3103128</p> |  | <p>GEL OPEN HEAD RING Diameter: 20 x 7,5 x 4,5 cm (DM AP013)</p> |
| <p>Code: C3103140</p> |  | <p>GEL PRONE HEAD REST 28 x 23 x 14,5 cm (DM AP022)</p> |
| <p>Code: C3103181</p> |  | <p>GEL PRONE HEAD REST Size 23 x 19 x 13 cm (DM AP023)</p> |
| <p>Code: C3103160</p> |  | <p>GEL PAIR OF HEEL GEL SUPPORT 20 x 11 x 7 cm (DM AP031)</p> |
| <p>Code: C3103197</p> |  | <p>GEL CHEST ROLL 30 x 15 x 10 cm (DM AP041)</p> |

| | | |
|----------------------------------|---|---|
| <p>Code: C3103740</p> |  | <p>GEL CHEST ROLL 40,5 x 10 x 8,5 cm (DM AP045)</p> |
| <p>Code: C3103130</p> |  | <p>GEL CHEST ROLL size 40,5 x 15 x 10 cm (DM AP042)</p> |
| <p>Code: C3103161</p> |  | <p>GEL CHEST ROLL size 51 x 15 x 10 cm (DM APO43)</p> |
| <p>Code: C3103143</p> |  | <p>GEL ARMBORAD PAD size 40 x 12,5 x 2 cm (DM AP071)</p> |
| <p>Code: C3103162</p> |  | <p>GEL ARMBORAD PAD size 60x12,5x2 cm (DM APO72)</p> |

| | | |
|----------------------------------|---|--|
| <p>Code: C3103179</p> |  | <p>GEL CONTOURED HEAD REST 19x19x6 cm (DM APO81)</p> |
| <p>Code: C3103375</p> |  | <p>GEL UNIVERSAL PATIENT POSITIONER size: 16x8x4,5 (DM APO91)</p> |
| <p>Code: C3103376</p> |  | <p>GEL UNIVERSAL PATIENT POSITIONER size: 33x7x5 cm (DM AP092)</p> |
| <p>Code: C3103144</p> |  | <p>GEL UNIVERSAL PATIENT POSITIONER size: 33x12x6 cm (DM AP093)</p> |
| <p>Code: C3103145</p> |  | <p>GEL UNIVERSAL PATIENT POSITIONER size: 36x12,5x7 cm (DM APO94)</p> |

| | | |
|----------------------------------|---|---|
| <p>Code: C3103182</p> |  | <p>GEL HEAD PAD size: 27x23x7 cm (DM AP110)</p> |
| <p>Code: C3103188</p> |  | <p>GEL WILSON FRAME PAD size: 75x25x2,5 - 2 pcs (DM AP210)</p> |
| <p>Code: C3103183</p> |  | <p>GEL OPERATING TABLE PAD size: 23x50x1 cm (DMAP301)</p> |
| <p>Code: C3103184</p> |  | <p>GEL OPERATING TABLE PAD size 99x50x1 cm (DM AP302)</p> |
| <p>Code: C3103158</p> |  | <p>GEL OPERATING TABLE PAD size: 50x50x1 cm (DM AP303)</p> |

| | | |
|----------------------------------|---|---|
| <p>Code: C3103185</p> |  | <p>GEL OPERATING TABLE PAD size: 193x86x1 cm (DM AP401)</p> |
| <p>Code: C3103186</p> |  | <p>GEL OPERATING TABLE PAD size 183x50x1 cm (DM AP402)</p> |
| <p>Code: C3103377</p> |  | <p>GEL GOEPEL KNEE CRUTCH PAD (DM AP803) - set 2 pcs</p> |
| <p>Code: C3103194</p> |  | <p>GEL BOOT STIRRUP PAD - 23x28x1,3 cm (DM AP901) - set 2 pieces</p> |
| <p>Code: C3103051</p> |  | <p>GEL OPERATING TABLE PAD size 22x17,5x1,2 (DM AP413) FOR SHOULDER PROTECTION WITH VELCRO CLOSURE</p> |
| <p>Code: C3102990</p> |  | <p>GEL ARMBOARD PAD size: 40x12,5x3,8 (DM AP073)</p> |

| | | |
|----------------------------------|---|--|
| <p>Code: C3103057</p> |  | <p>GEL OPERATING TABLE PAD WITH PERINEAL CUT size: 117x50x1 cm (DM AP409)</p> |
| <p>Code: C3102981</p> |  | <p>GEL OPERATING TABLE PAD size: 117x50x1,5 cm (DM-AP409A)</p> |
| <p>Code: C3102912</p> |  | <p>GEL OPERATING TABLE PAD size: 117x50x1,5 cm (DM-AP403A)</p> |
| <p>Code: C3103060</p> |  | <p>GEL OPERATING TABLE PAD size: 15x50x1,5 (DM AP408A)</p> |